

The Only One

JMP 2019

THE ENGINE COOLING SPECIALISTS



INNOBIZ

2019 JMP MARINE CATALOGUE

THE ENGINE COOLING SPECIALISTS

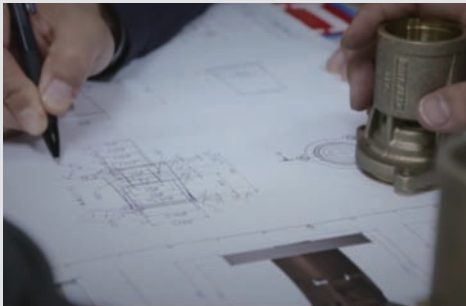
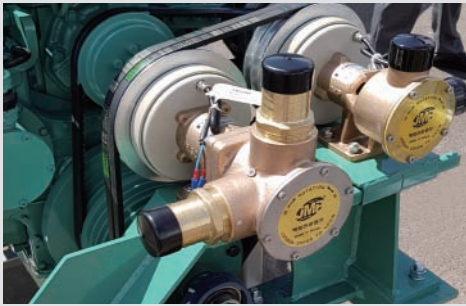

Head Office

12, Mora-ro, Sasang-gu, Busan, Korea (46903)
Tel : 82-51-302-7337~7339 Fax : 82-51-302-1255
Mail : jmp@jmp.co.kr
www.jmpusa.com (English) / www.jmp.co.kr (Korean)

JMP USA Office

13280 SW 131st, Suite 111 Miami,
FL 33186 - USA
Tel : 305-677-8330 Fax : 305-677-8337
Mail : jmp@jmpusa.com



CONTENTS

FLEXIBLE IMPELLER PUMPS

- 06 Flexible Impeller Pumps Introduction
- 08 Electro-Magnetic Clutch Pumps
- 09 General Multi-Purpose Pumps
- 11 Engine Cooling Pumps
- 16 JMP Pump Service Kit and Spare Parts Reference Guide
- 44 Performance Tables

FLEXIBLE IMPELLERS

- 46 Flexible Impellers Identification Guide
- 47 Impeller Cross Reference Guide
- 48 Flexible Impellers

SEA WATER STRAINERS

- 59 ST series
- 60 Parts list for ST Series

WORLDWIDE NETWORKS

Since 1977

DISTINCTLY DIFFERENT MARINE PUMP

KNOWING JMP IS KNOWING QUALITY AT ITS BEST

JMP has been developing Flexible Impeller Pumps along with top quality rubber impellers since 1976 being the first in our country and still a leader to this day. As a result we have grown to be a highly reputable and reliable company with a strong lead in the Asian market and continuously growing Worldwide. With experience and technology, there is nothing stopping us in becoming a world class company and the new Millennium Marine Partner. We have always strived on customer satisfaction which has allowed us to grow continuously for the last 30 plus years. It hasn't been easy but with the consistency in quality control we can now say that "we're not the first but the best." Our customers have given us the opportunity to prove just that and are now considered our partners.

Our Goal is to continue to grow in the Marine field with the best quality products that can endure the harshness of the seas and weather in keeping engines and generators working to its highest efficiency ever.



PARTNER COMPANY

KOHLER[®]



 **FEDERAL
MOGUL**

 **Vikoma**
Technology for a Cleaner Environment



Craftsman
MARINE

nanni
ENERGY IN BLUE

NEW THINKING. NEW POSSIBILITIES.
 **HYUNDAI SEASALL**



FLEXIBLE IMPELLER PUMPS

Impellers of the Best quality

Flexible impeller pumps provide an efficient solution to most marine pumping needs. The primary advantage of a flexible impeller pump is its self-priming capability. As the blades of the impeller are depressed and rebound, they create their own vacuum drawing fluid into the pumps (see operating principle). Pumps instantly with dry suction and can lift up to 3 meters, up to 9.5 meters when wet. Thus a flexible impeller pump being used in bilge, deck wash, or engine cooling need not be located below the water line or manually primed. An added feature of flexible impeller pumps is that they can pass fairly large particles without clogging or damaging the pump. This reduces the need for filtering the incoming fluid.

A common feature of all flexible impeller pumps is that they cannot be permitted to run dry for more than 30 seconds. Both the impeller and the seals depend upon the water for lubrication and will soon burn out if run dry. Worn parts are easily replaceable, and service Kits are available for all models.



Operating Principle

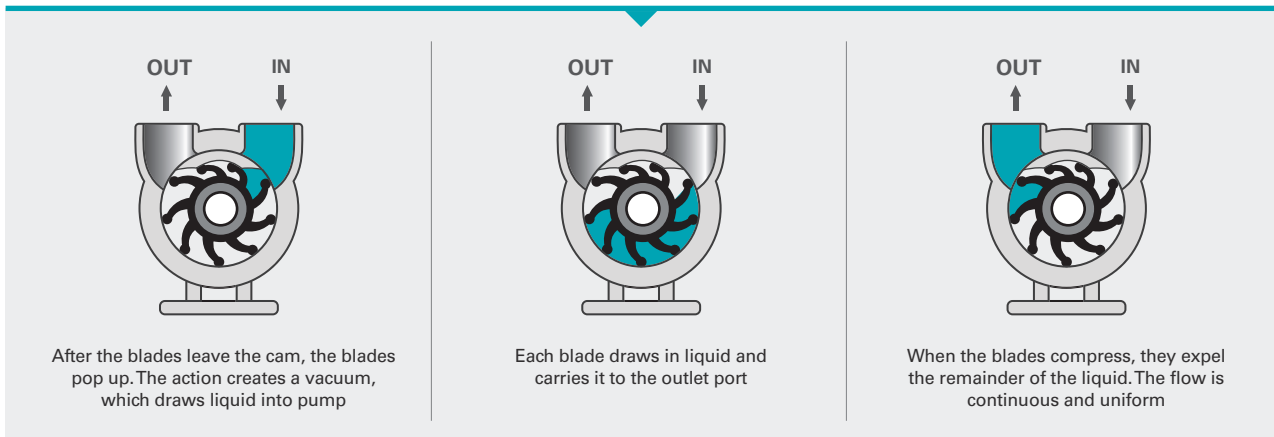

Determining Inlet and Outlet Port depending on Rotating Direction

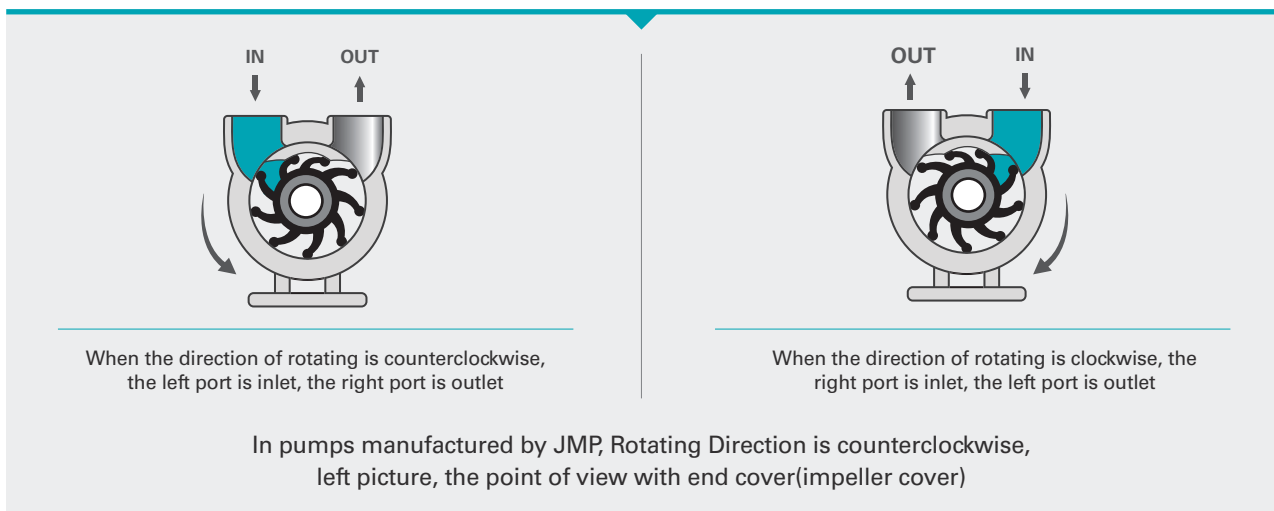

For Good Pumping

Pipe runs should always be kept as short and straight as possible, avoiding rising and going over obstructions, as this can create air-locks. Plumbing should be reinforced, non-collapsible hose of the recommended size. Flexible impeller pumps must not be run dry (more than 30 seconds). Bilge pumps and water pumps in particular should always be fastened to the boat structure to ensure their permanent location. Mount Flexible impeller pumps so that some water is left in the pump body when the pump is off. This will prolong impeller life and speed priming. Pumps must be installed with the overboard discharge well above the waterline to avoid water siphoning back into the vessel.

Features

- Strong bronze body
- Long life mechanical seal
- High performance and Long life flexible impeller
- Design with easy replacement of spare parts
- O-Ring seals at end cover instead of gasket

Others

- Manufacturing pumps to your specification are available.(OEM)
- Please contact us or dealers when for use on other applications.

ELECTRO-MAGNETIC CLUTCH PUMPS

JMP Electro Magnetic Clutch Pumps are multi-purpose pumps widely used in agricultural, industrial and marine applications. Especially in marine uses, it can be used in high capacity bilge or deckwash and emergency fire fighting pumps. JMP clutch pumps have high quality with high performance at a good price so you can use the clutch pumps with full satisfaction of performance and price.

You can also replace the worn parts easily. Service kits (minor and major) are available.

- High Power (High Torque), High Capacity
- Aluminum Pulley - Reduce Belt temperature (M40, M50, M65)
- Easy to change the Pulley
- Strong Bronze Body
- Full Rotation of Pump Ports with rotating Impeller housing (M50, M65)
- Power Coated clutch surface to resist rust



JPR-M25IP

Port Size	1", PIPE
Body	Bronze
Impeller	7400-01
Shaft Material	Stainless
Shaft Seal	Mechanical Seal
Pulley	7" / 1 groove / B section
Clutch	Electro-magnetic DC 12V / 24V
Flow (1800rpm)	106ℓ / min
Size (L x W x H,mm)	180 x 178 x 178
Weight (Appx)	8.0 kgs
Pulley 7" 2 groove / A section is available Service Kits (Replacement Parts) are available	



JPR-M40LH

Port Size	1-1/2", HOSE
Body	Bronze
Impeller	8001-01
Shaft Material	Stainless
Shaft Seal	Mechanical Seal
Pulley	8" / 1 groove / B section
Clutch	Electro-magnetic DC 12V / 24V
Flow (1800rpm)	268ℓ / min
Size (L x W x H,mm)	237 x 205 x 205
Weight (Appx)	15.0 kgs
Pulley 8" 1 groove / C section is available Service Kits (Replacement Parts) are available	



JPR-M50LPL

Port Size	2", PIPE
Body	Bronze
Impeller	8400-01
Shaft Material	Stainless
Shaft Seal	Mechanical Seal
Pulley	8" / 1 groove / B section
Clutch	Electro-magnetic DC 12V / 24V
Flow (1800rpm)	448ℓ / min
Size (L x W x H,mm)	300 x 205 x 205
Weight (Appx)	18.2 kgs
Pulley 8" 1 groove / C section is available Service Kits (Replacement Parts) are available	



JPR-M65LF

Port Size	2-1/2", FLANGE
Body	Bronze
Impeller	9100-01
Shaft Material	Stainless
Shaft Seal	Mechanical Seal
Pulley	8" / 1 groove / B section
Clutch	Electro-magnetic DC 24V
Flow (1800rpm)	591ℓ / min
Size (L x W x H,mm)	370 x 205 x 240
Weight (Appx)	33.5 kgs
Adaptor Kits are available (2" PIPE, 2-1/2" HOSE) Pulley 8" 1 groove / C section is available Service Kits (Replacement Parts) are available	

GENERAL MULTI-PURPOSE PUMPS

JMP general multi-purpose pumps are widely used in agricultural, industrial, and marine usages. Also, these pumps handle a wide range of liquid transfer, circulation and processing. JMP pumps can give you the most efficient solution which is fit for bottling systems, cleaning solution, sewage treatment and marine uses. You can also easily replace worn parts and service kits are available. The pumps give flow rates from 100ℓ /min up to 590ℓ /min (1"to 2-1/2") at 1800rpm.



JPR-25UP

Port Size	1", PIPE
Body	Bronze
Impeller	7400-01
Shaft Material	Stainless / 17mm
Shaft Seal	Mechanical Seal
Flow (1800rpm)	106ℓ / min
Size (L x W x H,mm)	158 x 103 x 112
Weight (Appx)	2.7 kgs

Service Kits (Replacement Parts) are available



JPR-32LP JPR-40LP

Port Size	1-1/4", PIPE	1-1/2", PIPE
Body	Bronze	Bronze
Impeller	7502-01	8001-01
Shaft Material	Stainless / 18mm	Stainless / 22mm
Shaft Seal	Mechanical Seal	Mechanical Seal
Flow (1800rpm)	158ℓ / min	268ℓ / min
Size (L x W x H,mm)	178 x 120 x 130	186 x 133 x 148
Weight (Appx)	3.6 kgs	4.8 kgs

Service Kits (Replacement Parts) are available



JPR-32UF JPR-40UF

Port Size	1-1/4", FLANGE	1-1/2", FLANGE
Body	Bronze	Bronze
Impeller	7502-01	8001-01
Shaft Material	Stainless / 18mm	Stainless / 22mm
Shaft Seal	Mechanical Seal	Mechanical Seal
Flow (1800rpm)	158ℓ / min	268ℓ / min
Size (L x W x H,mm)	185 x 145 x 135(209)	192 x 145 x 145(230)
Weight (Appx)	3.8 kgs	5.3 kgs

Service Kits (Replacement Parts) are available



JPR-VK2000 JPR-VK3000

Port Size	1-1/2", FLANGE	2", FLANGE
Body	Bronze	Bronze
Impeller	8101-01	8301-01
Shaft Material	Stainless / 25mm	Stainless / 25mm
Shaft Seal	Mechanical Seal	Mechanical Seal
Flow (1800rpm)	268ℓ / min	394ℓ / min
Size (L x W x H,mm)	255 x 152 x 133	275 x 153 x 149
Weight (Appx)	9.0 kgs	10.0 kgs

Service Kits (Replacement Parts) are available



JPR-50UF

Port Size	2", FLANGE
Body	Bronze
Impeller	8200-01
Shaft Material	Stainless / 22mm
Shaft Seal	Mechanical Seal
Flow (1800rpm)	394ℓ / min
Size (L x W x H,mm)	290 x 160 x 160
Weight (Appx)	10.5 kgs

Service Kits (Replacement Parts) are available



JPR-50LP

JPR-50LPL

Port Size	2", PIPE	2", PIPE
Body	Bronze	Bronze
Impeller	8200-01	8400-01
Shaft Material	Stainless / 22mm	Stainless / 22mm
Shaft Seal	Mechanical Seal	Mechanical Seal
Flow (1800rpm)	394ℓ / min	448ℓ / min
Size (L x W x H,mm)	270 x 140 x 160	283 x 140 x 160
Weight (Appx)	9.0 kgs	9.5 kgs

Service Kits (Replacement Parts) are available



JPR-65LF

Port Size	2-1/2", FLANGE
Body	Bronze
Impeller	9100-01
Shaft Material	Stainless / 30mm
Shaft Seal	Mechanical Seal
Flow (1800rpm)	591ℓ / min
Size (L x W x H,mm)	315 x 186 x 230
Weight (Appx)	20.0 kgs

Service Kits (Replacement Parts) are available
Adaptor Kits are available (2" PIPE, 2-1/2" HOSE)



ENGINE COOLING PUMPS

JMP Corporation is specialized in manufacturing heavy duty raw water pumps, marine engine cooling pumps and spare parts for more than 40 years. These are designed and manufactured especially for engine cooling applications. When you need specific engine cooling pumps please contact us.



JPR-D2500

Port Size	IN : 27mm OUT : 1" / PIPE
Impeller	7400-01
Size (L x W x H,mm)	170 x 94 x 117
Weight (Appx)	3.7 kgs
Engine model	DOOSAN - L034
Please contact the engine manufacturer	



JPR-D2505

Port Size	1", FLANGE
Impeller	7400-01
Size (L x W x H,mm)	155 x 120 x 123
Weight (Appx)	4.2 kgs
Engine model	DOOSAN-4V158TI, 4V222TI
Please contact the engine manufacturer	



JPR-D3200 JPR-D4000

Port Size	1-1/4", FLANGE	1-1/2", FLANGE
Impeller	7500-01	8002-01
Size (L x W x H,mm)	210 x 126 x 140	233 x 140 x 160
Weight (Appx)	5.9 kgs	7.5 kgs
Engine model	DOOSAN - L066TI	DOOSAN-2156, 2366
Please contact the engine manufacturer		



JPR-D4005 JPR-D5000

Port Size	1-1/2", HOSE	2", HOSE
Impeller	8001-01	8300-01
Size (L x W x H,mm)	175 x 160 x 160	240 x 160 x 160
Weight (Appx)	5.5 kgs	8.0kgs
Engine model	DOOSAN - L136	DOOSAN- MD196T
Please contact the engine manufacturer		



JPR-D4010

Port Size	1-1/2" IN : HOSE , OUT : FLANGE
Impeller	8001-01
Size (L x W x H,mm)	175 x 160 x 125
Weight (Appx)	6.0 kgs
Engine model	DOOSAN - L136T, L136TI, L086TI
Please contact the engine manufacturer	



JPR-D5005

Port Size	2" IN : HOSE , OUT : FLANGE
Impeller	8201-01
Size (L x W x H,mm)	216 x 160 x 293
Weight (Appx)	9.2 kgs
Engine model	DOOSAN - L126TI, 196T(NEW)
Please contact the engine manufacturer	



JPR-D5010

Port Size	2", FLANGE
Impeller	8309-01
Size (L x W x H,mm)	272 x 183 x 183
Weight (Appx)	9.0 kgs
Engine model	DOOSAN - 4L126
Please contact the engine manufacturer	



JPR-D6500

Port Size	2", FLANGE
Impeller	IMP0021
Size (L x W x H,mm)	370 x 185 x 185
Weight (Appx)	20.0 kgs
Engine model	DOOSAN - V158TI, V180TI, V222TI
Please contact the engine manufacturer	

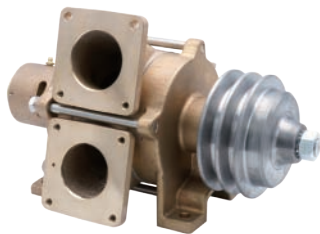

JPR-D6505

Port Size	2", FLANGE
Impeller	IMP0021
Size (L x W x H,mm)	377 x 205 x 222
Weight (Appx)	24.0 kgs
Engine model	DOOSAN - 4V18TI, 4V222TI
Please contact the engine manufacturer	



JPR-D6510

Port Size	2", FLANGE
Impeller	8326-01
Size (L x W x H,mm)	270 x 190 x 188
Weight (Appx)	12.6 kgs
Engine model	DOOSAN - V158TI, V180TI, V222TI
Please contact the engine manufacturer	



JPR-D6515

Port Size	2", FLANGE
Impeller	8359-01
Size (L x W x H,mm)	318 x 215 x 177
Weight (Appx)	16.8 kgs
Engine model	DOOSAN - 4V158TI, 4V222TI
Please contact the engine manufacturer	



JPR-HDS125

Port Size	1" , HOSE
Impeller	7306-01
Size (L x W x H,mm)	145 x 154 x 182
Weight (Appx)	4.5 kgs
Engine model	HYUNDAI SEASALL - U SERIES
Please contact the engine manufacturer	



JPR-HDS170

Port Size	ID : 32mm, OD : 40mm-HOSE
Impeller	7526-01
Size (L x W x H,mm)	144 x 176 x 165
Weight (Appx)	4.3 kgs
Engine model	HYUNDAI SEASALL - D SERIES
Please contact the engine manufacturer	



JPR-HDS200

Port Size	1 - 1/4", HOSE
Impeller	7400-01
Size (L x W x H,mm)	155 x 160 x 94
Weight (Appx)	3.6 kgs
Engine model	HYUNDAI SEASALL - R SERIES
Please contact the engine manufacturer	



JPR-HDS250

Port Size	ID : 36mm, OD : 44mm-HOSE
Impeller	7556-01
Size (L x W x H,mm)	179 x 187 x 120
Weight (Appx)	4.6 kgs
Engine model	HYUNDAI SEASALL - S SERIES
Please contact the engine manufacturer	



JPR-HDS400 JPR-HDS500

Port Size	2" , FLANGE	2" , FLANGE
Impeller	8326-01	8326-01
Size (L x W x H,mm)	250 x 172 x 147	250 x 172 x 147
Weight (Appx)	10.5 kgs	10.5 kgs
Engine model	HYUNDAI SEASALL - H SERIES	HYUNDAI SEASALL - L SERIES
Please contact the engine manufacturer		



JPR-FU40

Port Size	1-1/2", PIPE
Impeller	8001-01
Size (L x W x H,mm)	180 x 154 x 135
Weight (Appx)	4.5 kgs
Engine model	HYUNDAI-H6D2TA
Service Kits (Replacement Parts) are available	



JPR-FU50

Port Size	2" , FLANGE
Impeller	8201-01
Size (L x W x H,mm)	255 x 183 x 130
Weight (Appx)	9.0 kgs
Engine model	HYUNDAI - H6D7TA
Service Kits (Replacement Parts) are available	



JPR-HME25

Port Size	1", PIPE
Impeller	7426-01
Size (L x W x H,mm)	160 x 125 x 154
Weight (Appx)	5 kgs
Engine model	HYUNDAI MARINE M4D SERIES
Please contact the engine manufacturer	



JPR-HME32

Port Size	1-1/4", PIPE
Impeller	7526-01
Size (L x W x H,mm)	171 x 132 x 110
Weight (Appx)	4 kgs
Engine model	HYUNDAI MARINE M6D16 SERIES
Please contact the engine manufacturer	



JPR-HME40A

Port Size	1 - 1/2", FLANGE
Impeller	8100-01
Size (L x W x H,mm)	177 x 190 x 133
Weight (Appx)	6.5 kgs
Engine model	HYUNDAI MARINE M6D30 SERIES
Please contact the engine manufacturer	



JPR-HME50

Port Size	2", FLANGE
Impeller	8301-01
Size (L x W x H,mm)	237 x 160 x 140
Weight (Appx)	7.8 kgs
Engine model	HYUNDAI MARINE M6D33, M6D35
Please contact the engine manufacturer	



JPR-KL10IP JPR-KL10IP2

Port Size	3/8-NPT , PIPE	3/8-NPT , PIPE
Impeller	7172-01	7172-01
Size (L x W x H,mm)	100 x 90 x 90	112 x 90 x 90
Weight (Appx)	1.8 kgs	1.8 kgs
Engine model	SHERWOOD G910P	SHERWOOD G907P
Service Kits (Replacement Parts) are available		



JPR-WB08IP

Port Size	3/8-NPT , PIPE
Impeller	7050-01
Size (L x W x H,mm)	91 x 87 x 82
Weight (Appx)	1.3 kgs
Engine model	WESTERBEKE / 48080
Service Kits (Replacement Parts) are available	



JPR-PK10IH

Port Size	OD : Ø18 , HOSE
Impeller	7001-01
Size (L x W x H,mm)	122 x 104 x 72
Weight (Appx)	1.1 kgs
Engine model	KOHLER GENERATOR / PERKINS
Service Kits (Replacement Parts) are available	



CM08IH(1,2,3)

Port Size	Ø15 , HOSE
Impeller	7070-01
Size (L x W x H,mm)	102 x 114 x 80
Weight (Appx)	1.1 kg
Engine model	CRAFTSMAN 2,3,4 CYL
Service Kits (Replacement Parts) are available	



CM10LH

Port Size	Ø21 , HOSE
Impeller	7100-01
Size (L x W x H,mm)	135 x 120 x 93
Weight (Appx)	1.4 kg
Engine model	CRAFTSMAN 6 CYL
Service Kits (Replacement Parts) are available	



CP25UH

Port Size	OD Ø32 , HOSE
Impeller	7139-01
Size (L x W x H,mm)	124x114x117
Weight (Appx)	2.1 kg
Engine model	Indma, Volvo, Marine power, PCM
Service Kits (Replacement Parts) are available	



JMP PUMP SERVICE KIT AND SPARE PARTS REFERENCE GUIDE

NO	PUMP MODEL	INLET	OUTLET	IMPELLER	MINOR KIT	MAJOR KIT	BEARING DRIVE	BEARING SEAL	SCREW (END COVER)	CAMSET (SCREW+GASKET)	END COVER
1	JPR-M25IP	1"	1"	7400-01	JSM0008	JSK0050	BER0001	BER0001	BOL0080	CAMSET000301	COV000301
2	JPR-M40LH-1B24	1-1/2"	1-1/2"	8001-01	JSM0038	JSK0009	BER0003	BER0003	BOL0081	CAMSET0005	COV0005
3	JPR-M50LPL	2"	2"	8400-01	JSM0012	JSK0013	BER0006	BER0006	BOL0081	CAMSET0008	COV0008
4	JPR-M65LF	2-1/2"	2-1/2"	9100-01	JSM0015	JSK0016	BER0023	BER0023	BOL0006	CAMSET0009	COV0009
5	JPR-25UP	1"	1"	7400-01	JSM0001	JSK0001	BER0002	BER0002	BOL0080	CAMSET0003	COV0003
6	JPR-32LP	1-1/4"	1-1/4"	7502-01	JSM0010	JSK0003	BER0001	BER0001	BOL0080	CAMSET0004	COV0004
7	JPR-40LP	1-1/2"	1-1/2"	8001-01	JSM0038	JSK0006	BER0003	BER0003	BOL0081	CAMSET0005	COV0005
8	JPR-32UF	1-1/4"	1-1/4"	7502-01	JSM0010	JSK0004	BER0001	BER0001	BOL0080	CAMSET0004	COV0004
9	JPR-40UF	1-1/2"	1-1/2"	8001-01	JSM0038	JSK0007	BER0003	BER0003	BOL0081	CAMSET0005	COV0005
10	JPR-VK2000	1-1/2"	1-1/2"	8101-01	JSM001401	JSK011201	BER0036	BER0036	BOL0081	CAMSET0005	COV0005
11	JPR-VK3000	2"	2"	8301-01	JSM001601	JSK011301	BER0036	BER0036	BOL0081	CAMSET0016	COV0005
12	JPR-50UF	2"	2"	8200-01	JSM0013	JSK0057	BER0006	BER0006	BOL0081	CAMSET0013	COV0005
13	JPR-50LP	2"	2"	8200-01	JSM0011	JSK0011	BER0006	BER0006	BOL0081	CAMSET0006	COV0005
14	JPR-50LPL	2"	2"	8400-01	JSM0012	JSK0012	BER0006	BER0006	BOL0081	CAMSET0008	COV0008
15	JPR-65LF	2-1/2"	2-1/2"	9100-01	JSM0015	JSK0015	BER0023	BER0023	BOL0006	CAMSET0009	COV0009
16	JPR-D2500	27mm	1"	7400-01	JSM004201	JSK004201	BER0001	BER0001	BOL0080	CAMSET000301	COV0003
17	JPR-D2505	1"	1"	7400-01	JSM004201	JSK0108	BER0018	BER0018	BOL0080	CAMSET000301	COV0003
18	JPR-D3200	1-1/4"	1-1/4"	7500-01	JSM0036	JSK0036	BER0003	BER0003	BOL0081	CAMSET000401	COV0015
19	JPR-D4000	1-1/2"	1-1/2"	8002-01	JSM0037	JSK0037	BER0006	BER0006	BOL0081	CAMSET0005	COV0005
20	JPR-D4005	1-1/2"	1-1/2"	8001-01	JSM0038	JSK0038	BER0018	BER0018	BOL0081	CAMSET0005	COV0005
21	JPR-D4010	1-1/2"	1-1/2"	8001-01	JSM0038	JSK0038	BER0018	BER0018	BOL0081	CAMSET0005	COV0005
22	JPR-D5000	2"	2"	8300-01	JSM0039	JSK0039	BER0005	BER0005	BOL0081	CAMSET0015	COV0005
23	JPR-D5005	2"	2"	8201-01	JSM0041	JSK004101	BER0025	BER0024	BOL0081	CAMSET0016	COV0005
24	JPR-D5010	2"	2"	8309-01	JSM0147	JSK0147	BER0060	BER0006	BOL0081	CAMSET0016	COV0054
25	JPR-D6500	2"	2"	IMP0021	JSM0040	JSK0040	BER0013	BER0007	N/A	N/A	N/A
26	JPR-D6505	2"	2"	IMP0021	JSM0040	JSK0054	BER0013	BER0007	N/A	N/A	N/A
27	JPR-D6510	2"	2"	8326-01	JSM0131	JSK0131	BER0060	BER0006	BOL0081	CAMSET0028	COV0035
28	JPR-D6515	2"	2"	8359-01	JSM0132	JSK0132	BER0060	BER0006	BOL0006	CAMSET0032	COV0056
29	JPR-HDS125	1"	1"	7306-01	JSM0066	JSK0061	BER0045	BER0045	BOL0080	CAMSET0020	COV0003
30	JPR-HDS170	1-1/4"	1-1/4"	7526-01	JSM0067	JSK0062	BER0044	N/A	BOL0080	CAMSET0004	COV0004
31	JPR-HDS200	1-1/4"	1-1/4"	7400-01	JSM0116	JSK0116	BER0045	BER0045	BOL0080	CAMSET000301	COV0003
32	JPR-HDS250	1-1/2"	1-1/2"	7556-01	JSM0068	JSK0060	BER0015	BER0001	BOL0080	CAMSET0022	COV0004
33	JPR-HDS400	2"	2"	8326-01	JSM0065	JSK0063	BER0005	BER0005	BOL0081	CAMSET0030	COV0005
34	JPR-HDS500	2"	2"	8326-01	JSM0065	JSK0063	BER0005	BER0005	BOL0081	CAMSET0030	COV0005
35	JPR-FU40	1-1/2"	1-1/2"	8001-01	JSM0017	JSK0019	BER0004	BER0004	BOL0081	CAMSET0005	COV0005
36	JPR-FU50	2"	2"	8201-01	JSM0018	JSK0110	BER0005	BER0005	BOL0081	CAMSET0016	COV0005
37	JPR-HME25	1"	1"	7426-01	JSM0034	JSK0066	BER0015	N/A	BOL0080	CASET000301	COV0003
38	JPR-HME32	1-1/4"	1-1/4"	7526-01	JSM0035	JSK0090	BER0051	N/A	BOL0080	CAMSET0004	COV0004
39	JPR-HME40A	1-1/2"	1-1/2"	8100-01	JSM0058	JSK0059	BER0010	N/A	BOL0081	CAMSET0005	COV0005
40	JPR-HME50	2"	2"	8301-01	JSM0043	JSK0087	BER0005	BER0005	BOL0081	CAMSET0016	COV0005
41	JPR-KL10IP	3/8"	3/8"	7172-01	JSM0114	JSK0114	BER0046	BER0046	BOL0080	CAMSET0029	COV0039
42	JPR-KL10IP-2	3/8"	3/8"	7172-01	JSM0114	JSK0086	BER0046	BER0046	BOL0080	CAMSET0029	COV0039
43	JPR-WB08IP	3/8"	3/8"	7050-01	JSM0089	JSK0089	BER0048	BER0048	BOL0144	N/A	COV0042
44	JPR-PK10IH	18mm	18mm	7001-01	JSM0093	JSK0083	BER0048	BER0048	BOL0144	N/A	COV0040
45	JPR-CM08IH	15mm	15mm	7070-01	JSM0092	JSK0088	BER0056	BER0056	BOL0080	N/A	COV0044
46	JPR-CM10LH	21mm	21mm	7100-01	JSM0115	JSK0115	BER0046	BER0046	BOL0144	CAMSET0033	COV0045

*All parts information in the list is only for reference purposes and the part numbers are based on JMP model name and system code. Please contact JMP if you need detailed information.

END COVER PACKING	KEY DRIVE	SEAL	RETAINER DRIVE	RETAINER SEAL	SHAFT	SLINGER	SNAP RING SEAL	SNAP RING DRIVE	WEAR PLATE	CLUTCH/ DRIVE
ORG0013	KEY0003	MCSSET0008	N/A	RET0021	SHA0055	N/A	N/A	N/A	WER0001	
ORG0015	KEY0003	MCSSET0003	N/A	RET0007	SHA0009	SLI0003	SNP0008	SNP0011	WER0003	
GAK0019	KEY0003	MCSSET0003	N/A	RET0007	SHA0013	N/A	SNP0008	SNP0013	WER0004	
ORG0012	KEY0008	MCSSET0005	N/A	N/A	SHA0015	SLI0004	SNP0019	SNP0016	WER0005	
ORG0013	KEY0002	MCSSET0008	RET0030	N/A	SHA0001	SLI0001	SNP0006	SNP0009	N/A	
ORG0014	KEY0002	MCSSET0002	RET0031	N/A	SHA0003	SLI0002	SNP0007	SNP0010	WER0002	
ORG0015	KEY0005	MCSSET0003	RET0008	N/A	SHA0006	SLI0003	SNP0008	SNP0011	WER0003	
ORG0014	KEY0002	MCSSET0002	RET0031	N/A	SHA0004	SLI0002	SNP0007	SNP0010	WER0002	
ORG0015	KEY0005	MCSSET0003	RET0008	N/A	SHA0007	SLI0003	SNP0008	SNP0011	WER0003	
ORG0015	N/A	MCSSET0003	RET0017	RET0009	SHA0061	SLI0003	N/A	N/A	WER0003	
ORG0015	N/A	MCSSET0003	RET0017	RET0009	SHA0062	SLI0003	N/A	N/A	WER0003	
ORG0015	KEY0015	MCSSET0003	RET0010	RET0007	SHA003001	N/A	N/A	SNP0013	WER0013	
ORG0015	KEY0007	MCSSET0003	RET0010	RET0007	SHA0011	SLI0003	SNP0008	SNP0013	WER0003	
GAK0019	KEY0007	MCSSET0003	RET0010	RET0007	SHA0011	N/A	SNP0008	SNP0013	WER0004	
ORG0012	KEY0006	MCSSET0005	COV0026	N/A	SHA0014	SLI0004	SNP0019	SNP0016	WER0005	
ORG0013	KEY0010	MCSSET0008	RET0031	RET0021	SHA004002	SLI0001	SNP0006	SNP0010	WER0001	PUL0010
ORG0013	N/A	MCSSET0008	N/A	RET0012	SHA0060	SLI0001	SNP0006	SNP0012	WER0001	
ORG0014	KEY0002	MCSSET0003	RET0008	RET0007	SHA0034	SLI0003	SNP0008	SNP0011	WER0002	
ORG0015	KEY0006	MCSSET0003	RET0010	RET0007	SHA0035	SLI0003	SNP0008	SNP0013	WER0003	
ORG0015	N/A	MCSSET0003	N/A	RET0012	SHA0036	SLI0003	SNP0008	SNP0012	WER0003	
ORG0015	N/A	MCSSET0003	N/A	RET0012	SHA0036	SLI0003	SNP0008	SNP0012	WER0003	
ORG0015	KEY0013	MCSSET0003	N/A	RET0012	SHA0037	SLI0003	SNP0008	SNP0013	WER0003	
ORG0015	KEY0013	MCSSET0003	N/A	RET0012	SHA0039	SLI0003	SNP0008	SNP0014	WER0003	
ORG0015	KEY0015	MCSSET0003	RET0010	RET0008	SHA0127	SLI0003	SNP0008	SNP0013	WER0026	
GAK0021	KEY0014	MCSSET0004	RET0006	RET0007	SHA0038	SLI0003	N/A	SNP0004	N/A	PUL0009
GAK0021	KEY0014	MCSSET0004	RET0006	RET0007	SHA0059	SLI0003	N/A	SNP0004	N/A	PUL0017
ORG0015	KEY0015	MCSSET0003	RET0010	RET0007	SHA0131	SLI0003	SNP0008	SNP0013	WER0018	PUL0037
ORG0043	KEY0015	MCSSET0004	RET0010	RET0008	SHA0132	SLI0003	SNP0008	SNP0013	WER0020	PUL0038
ORG0013	KEY0010	MCSSET0008	N/A	N/A	SHA0072	SLI0005	SNP0006	SNP0009	N/A	PUL0022
ORG0014	N/A	MCSSET0014	N/A	RET0021	SHA0065	SLI0002	SNP000301	SNP0010	WER0002	
ORG0013	KEY0010	MCSSET0008	N/A	N/A	SHA0072	SLI0005	SNP0006	SNP0009	WER0001	PUL0029
ORG0014	N/A	MCSSET0014	N/A	RET0021	SHA0066	SLI0002	SNP000301	SNP0010	WER0002	
ORG0015	KEY0013	MCSSET0003	N/A	RET001301	SHA0071	SLI0003	N/A	SNP0013	WER0018	GEA0013
ORG0015	KEY0013	MCSSET0003	N/A	RET001301	SHA0071	SLI0003	N/A	SNP0013	WER0018	GEA0013
ORG0015	KEY0013	MCSSET0003	N/A	RET0009	SHA0016	N/A	N/A	SNP0011	WER0003	
ORG0015	KEY0013	MCSSET0003	N/A	RET0012	SHA0018	SLI0003	N/A	SNP0013	WER0003	
ORG0013	KEY0002	MCSSET0008	RET0031	RET0028	SHA0081	SLI0005	SNP0006	SNP0010	WER0001	PUL0023
ORG0014	KEY0002	MCSSET0014	RET0008	RET0039	SHA0089	SLI0006	SNP000301	SNP0011	WER0002	
ORG0015	KEY0013	MCSSET0003	N/A	RET0037	SHA0080	SLI0003	SNP0008	SNP0013	WER0003	
ORG0015	KEY0013	MCSSET0003	N/A	RET0036	SHA0090	SLI0003	SNP0008	SNP0013	WER0003	
ORG0032	N/A	MCSSET0017	N/A	N/A	SHA0073	N/A	SNP0021	SNP0022	N/A	PUL0020
ORG0032	KEY0025	MCSSET0017	N/A	N/A	SHA007301	N/A	SNP0021	SNP0022	N/A	PUL002001
ORG0052	N/A	MCSSET0020	N/A	RET0045	SHA0099	N/A	SNP0026	SNP0024	WER0023	
ORG0056	N/A	MCSSET0018	N/A	RET0041	SHA0092	N/A	SNP0023	SNP0024	WER0021	
ORG0052	N/A	RET0046	N/A	RET0046	SHA0101	N/A	N/A	SNP0024	N/A	
GAK0060	KEY0027	RET0013	N/A	RET0013	SHA0102	N/A	N/A	N/A	WER0006	PUL0016

CATERPILLAR ENGINES

SEA(RAW) WATER PUMPS AND PARTS

JPR-CT353



- ENGINE MODEL
D343, D353
- PUMP P/N
3N1888

	JMP	CAT	DESCRIPTION	QTY	REMARK
1	JPR-CT353	3N1888	SEA WATER PUMP	1	
2	BER0005	1B3867	BALL BEARING	2	
3	BOL0005	23501649	SCREW, END COVER	6	
4	CAMSET0018	3N4860	CAM LINER	1	ALUMINUM BRONZE
5	COV0011	3N4854	END COVER	1	
6	GAK0008	3N4861	GASKET, END COVER	1	
7	8300-01	3N4859	IMPELLER	1	
8	KEY0019	1B8712	KEY	1	
9	MCSSET0007	3N5632	MECHANICAL SEAL SET	1	
10	ORG0003	3N4866	O-RING	2	
11	PIN0002	3N4855	DOWEL PIN	2	
12	RET001301	3N4863	OIL SEAL	1	
13	SHA0025	3N5692	SHAFT	1	
14	SNP0008	3N7759	SNAP RING (SMALL)	1	
15	SNP0013	1L4775	SNAP RING (LARGE)	1	
16	WER0010	3N4862	WEAR PLATE	2	
17	GEA0009	4L8469	GEAR	1	20TEETH DRIVE
18	JSM0005	N/A	MINOR KIT	1	
19	JSK0026	N/A	MAJOR KIT	1	ALL INTERNAL PARTS

JPR-CT3054



- ENGINE MODEL
3054, 3056
- PUMP P/N
4255411

	JMP	CAT	DESCRIPTION	QTY	REMARK
1	JPR-CT3054	4255411	SEA WATER PUMP	1	
2	BER0035	7F9993	BALL BEARING	2	
3	BOL0163	1960401	SCREW, END COVER	6	
4	CAMSET0046	1960386	CAM SET	1	
5	COV0063	4415564	END COVER	1	
6	GAK0016	1960392	GASKET, END COVER	1	
7	7400-01	2637536	IMPELLER	1	
8	MCSSET0008	4204328	MECHANICAL SEAL SET	1	ONLY FOR CT3054, CT0440
9	ORG0057	N/A	O-RING, MOUTING	1	
10	RET0013	1991336	OIL SEAL	1	
11	SHA0158	1960399	SHAFT	1	
12	SNP0006	1960387	SNAP RING	1	
13	SNP0010	1960397	SNAP RING	1	
14	WER0029	1960388	WEAR PLATE	1	
15	GEA0034	1960398	GEAR	1	
16	JSM0142		MINOR KIT	1	
17	JSK0142		MAJOR KIT	1	ALL INTERNAL PARTS

JPR-CT3306



- ENGINE MODEL
3306 SERIES
- PUMP P/N
5N9357

	JMP	CAT	DESCRIPTION	QTY	REMARK
1	JPR-CT3306	5N9357	SEA WATER PUMP	1	
2	BER0036	7L7508	BALL BEARING	1	
3	BOL0099	3F7586	SCREW, END COVER	5	
4	CAMSET000502	6L8790	CAM SET	1	WITH SCREW, PACKING
5	COV0006	5N5288	END COVER	1	
6	GAK0007	1L4785	GASKET, END COVER	1	
7	8100-01	5N9360	IMPELLER	1	
8	MCSSET0003	7L2130	MECHANICAL SEAL SET	1	
9	ORG0044	8F3469	O-RING	1	
10	RET0011	4L9021	OIL SEAL	1	
11	SHA0050	5N9359	SHAFT	1	
12	SLI0003	1L4786	SLINGER	1	
13	SNP0005	4M5285	SNAP RING (SMALL)	1	
14	SNP0013	1L4775	SNAP RING (LARGE)	1	
15	WER0009	4L8473	WEAR PLATE	1	
16	JSM0007	N/A	MINOR KIT	1	
17	JSK002901	N/A	MAJOR KIT	1	ALL INTERNAL PARTS

JPR-CT3406



■ **ENGINE MODEL**
3406 SERIES

■ **PUMP P/N**
3N4851

	JMP	CAT	DESCRIPTION	QTY	REMARK
1	JPR-CT3406	3N4851	SEA WATER PUMP	1	
2	BER0005	1B3687	BALL BEARING	2	
3	BOL0005	3F7856	SCREW, END COVER	6	
4	CAMSET0018	3N4860	CAM LINER	1	ALUMINUM BRONZE
5	COV0011	3N4854	END COVER	1	
6	GAK0008	3N4861	GASKET, END COVER	1	
7	8300-01	3N4859	IMPELLER	1	
8	MCSSET0007	3N5632	MECHANICAL SEAL SET	1	
9	PIN0002	3N4855	DOWEL PIN	2	
10	RET001301	3N4863	OIL SEAL	1	
11	SHA0046	3N4858	SHAFT	1	
12	SLI0003	1L4786	SLINGER	1	
13	SNP0008	3N7759	SNAP RING (SMALL)	1	
14	SNP0013	1L4775	SNAP RING (LARGE)	1	
15	WER0010	3N4862	WEAR PLATE	2	
16	JSM0005	N/A	MINOR KIT	1	
17	JSK002601	N/A	MAJOR KIT	1	ALL INTERNAL PARTS

JPR-CT3408



■ **ENGINE MODEL**
3408 SERIES

■ **PUMP P/N**
3N7714

	JMP	CAT	DESCRIPTION	QTY	REMARK
1	JPR-CT3408	3N7714	SEA WATER PUMP	1	PARTS ONLY
2	BER0024	2L5271	BALL BEARING	1	
3	BER0057	2H3829	BALL BEARING	1	
4	BOL0157	5P8026	PIN-COTTER	1	
5	IMP002602	3N8214	IMPELLER	1	
6	KEY0022	1487992	KEY	1	
7	MCSSET0010	5N6054	MECHANICAL SEAL SET	1	
8	ORG002901	3N8201	O-RING	1	
9	PORT002	5N4503	PLATE PORT	2	
10	RET0023	5N2903	OIL SEAL	1	
11	RIG0003	3N8213	DISTANCE RING	1	
12	SHA0047	3N8203	SHAFT	1	
13	SNP0014	4L9020	SNAP RING	2	
15	SPC0004	3N8211	SPACER	1	30 X 40 X 17

JPR-CT3412



■ **ENGINE MODEL**
3412 SERIES

■ **PUMP P/N**
3N7790, 7C3613

	JMP	CAT	DESCRIPTION	QTY	REMARK
1	JPR-CT3412	7C3613	SEA WATER PUMP	1	
2	BER0037	3N8463	BALL BEARING	1	
3	BER0038	4M6107	BALL BEARING	1	4M6107+8T0209
4	BOL0097	4P9312	COTTER PIN	1	
5	BOL0110	8B7614	SLOTTED NUT	1	
6	CLP0100	3N8469	CLAMP ASSEMBLY(LARGE)	1	
7	CLP0101	3N8468	CLAMP ASSEMBLY(SMALL)	2	
8	IMP0026	3N8449	IMPELLER	1	
9	KEY0017	1756716	KEY	1	
10	MCSSET0009	5N6055	MECHANICAL SEAL SET	1	
11	PORT001G	5N4504	PORT PLATE	2	
12	ORG0023	N/A	O-RING, PORT PLATE	2	
13	ORG0024	N/A	O-RING	1	
14	ORG0029	3N8462	O-RING	1	
15	RET0020	5N2902	OIL SEAL	1	
16	RIG0001	3N8452	DISTANCE RING	1	
17	SHA0048	7C3493	SHAFT	1	
18	SNP0016	1075565	SNAP RING	1	
19	SNP0018	IJ6472	SNAP RING	1	
20	SPC0003	3N8442	SPACER	1	
21	SPC0005	5N2904	SPACER	1	
22	SPC0006	3N8445	SPACER	1	
23	JMK0002	N/A	SEAL KIT	1	INCLUDES No.4, 10, 14, 15, 20
24	JSK0124	N/A	MAJOR KIT	1	ALL INTERNAL PARTS

JPR-CT3508



■ **ENGINE MODEL**
3508 SERIES

■ **PUMP P/N**
5N2600, 7C3614

JMP	CAT	DESCRIPTION	QTY	REMARK	
1	JPR-CT3508	7C3614	SEA WATER PUMP	1	
2	BER0037	3N8463	BALL BEARING	1	
3	BER0038	4M6107	BALL BEARING	1	4M6107+8T0209
4	BOL0097	4P9312	COTTER PIN	1	
5	BOL0110	8B7614	SLOTTED NUT	1	
6	CLP0100	3N8469	CLAMP ASSEMBLY(LARGE)	1	
7	CLP0101	3N8468	CLAMP ASSEMBLY(SMALL)	2	
8	IMP0063	5N2618	IMPELLER	1	
9	KEY0017	1756716	KEY	1	
10	MCSSET0009	5N6055	MECHANICAL SEAL SET	1	
11	PORT001G	5N4504	PORT PLATE	2	
12	ORG0023	N/A	O-RING, PORT PLATE	2	
13	ORG0024	N/A	O-RING	1	
14	ORG0029	3N8462	O-RING	1	
15	RET0020	5N2902	OIL SEAL	1	
16	RIG0001	3N8452	DISTANCE RING	1	
17	SHA0048	7C3493	SHAFT	1	
18	SNP0016	1075565	SNAP RING	1	
19	SNP0018	IJ6472	SNAP RING	1	
20	SPC0003	3N8442	SPACER	1	
21	SPC0005	5N2904	SPACER	1	
22	SPC0006	3N8445	SPACER	1	
23	JMK0002	N/A	SEAL KIT	1	INCLUDES No.4, 10, 14, 15, 20
24	JSK0125	N/A	MAJOR KIT	1	ALL INTERNAL PARTS

JPR-CT0440



■ **ENGINE MODEL**
C 4.4

■ **PUMP P/N**
4255412

JMP	CAT	DESCRIPTION	QTY	REMARK	
1	JPR-CT0440	4255412	SEA WATER PUMP	1	RE-ENGINEERED
2	BER0035	7F9933	BALL BEARING	2	
3	BOL0080	2637539	SCREW, END COVER	4	
4	CAMSET0039	2637535	CAM SET	1	
5	COV0047	4415566	END COVER	1	COV0047 - STAINLESS
6	7400-01	2637536	IMPELLER	1	
7	MCSSET0008	4204328	MECHANICAL SEAL SET	1	ONLY FOR CT3054, CT0440
8	ORG0067	1960392	O-RING, END COVER	1	
9	RET0013	1991336	OIL SEAL	1	
10	SHA0158	1960399	SHAFT	1	
11	SNP0006	1960387	SNAP RING	1	
12	SNP0010	1960397	SNAP RING	1	
13	WER0029	1960388	WEAR PLATE	1	
14	GEA0035	2637540	GEAR	1	
15	JSM0143	N/A	MINOR KIT	1	
16	JSK0143	N/A	MAJOR KIT	1	ALL INTERNAL PARTS

JPR-S7632



■ **ENGINE MODEL**
C7, C9

■ **PUMP P/N**
1674252, 1706116

JMP	CAT	DESCRIPTION	QTY	REMARK	
1	JPR-S7632	1706116	SEA WATER PUMP	1	RE-ENGINEERED
2	BER0039	8H4320	BALL BEARING	2	
3	BOL0006	3E9854	HEX BOLT, END COVER	3	
4	BOL0036	N/A	SPRING WASHER, END COVER	3	
5	CAMSET0031	1131110	CAM SET	1	WITH SCREW, PACKING
6	COV0036	7E0317	END COVER	1	
7	7608-01	7E0321	IMPELLER-PUMP	1	7E0321 - JMP 7600-01
8	MCSSET0014	2003052	MECHANICAL SEAL SET	1	
9	SNP000301	N/A	SNAP RING (SMALL)	1	
10	ORG0030	8T2944	O-RING, END COVER	1	
11	RET0035	1149088	OIL SEAL	1	
12	SHA0076	6I2072	SHAFT	1	
13	SNP0011	5F5078	SNAP RING (LARGE)	1	
14	WER0019	7E0328	WEAR PLATE	1	
15	JSM0002	N/A	MINOR KIT	1	
16	JSK0072	N/A	MAJOR KIT	1	ALL INTERNAL PARTS

JPR-CT1200R



■ ENGINE MODEL
C12

■ PUMP P/N
3596661

	JMP	CAT	DESCRIPTION	QTY	REMARK
1	JPR-CT1200R	3596661	SEA WATER PUMP	1	PARTS ONLY
2	BER0010	2B2887	BALL BEARING	1	
3	BER0064	2F5721	BALL BEARING	1	
4	BOL0006	3E9854	HEX BOLT, END COVER	5	
5	BOL0036	N/A	SPRING WASHER, END COVER	5	
6	8359-01	2968388	IMPELLER	1	
7	COV0038	1095325	END COVER	1	
8	CAMSET003201	1230496	CAM LINER SET	1	ALUMINUM BRONZE 1 PCS
9	ORG0043	1230494	QUAD RING	2	
10	ORG0054	N/A	V-RING	1	
11	MCSSET0027	1950763	MECHANICAL SEAL SET	1	
12	PIN0011	1230495	PIN, CAM LINER	1	
13	RET0042	N/A	OIL SEAL	1	
14	SHA0146	3596660	SHAFT	1	
15	SNP0008	1974870	SNAP RING(M-SEAL)	1	
16	SNP0013	N/A	SNAP RING	1	
17	SPC0012	N/A	SPACER	1	
18	SPC0035	N/A	SPACER	1	
19	WER0020	1095322	WEAR PLATE	1	
20	JSM0138	N/A	MINOR KIT	1	
21	JSK0138	N/A	MAJOR KIT	1	ALL INTERNAL PARTS

JPR-CT1800R



■ ENGINE MODEL
C18

■ PUMP P/N
3754703

	JMP	CAT	DESCRIPTION	QTY	REMARK
1	JPR-CT1800R	3754703	SEA WATER PUMP	1	PARTS ONLY
2	BER0063	N/A	BALL BEARING	2	
3	BOL0006	3E9854	HEX BOLT, END COVER	5	
4	BOL0036	N/A	SPRING WASHER, END COVER	5	
8	CAMSET0032	1369490	CAM LINER SET	1	ALUMINUM BRONZE 1 PCS
9	COV0038	1095325	END COVER	1	
10	COV0041	N/A	COVER - BEARING	1	
11	8359-01	2968388	IMPELLER	1	
12	MCSSET0027	1950763	MECHANICAL SEAL SET	1	
13	KEY0034	1733998	KEY, WOODRUFF	1	
14	ORG0043	1230494	QUAD RING	2	
15	ORG0054	N/A	O-RING, MOUNTING	1	
16	PIN0011	1230495	PIN, CAM LINER	1	
17	RET0042	N/A	OIL SEAL	1	
18	SHA0147	N/A	SHAFT	1	
19	SNP0008	N/A	SNAP RING (M-SEAL)	1	
20	SNP0013	N/A	SNAP RING	1	
21	SPC0012	N/A	SPACER	1	
22	SPC0036	2389935	SPACER	1	
23	WER0020	1095322	WEAR PLATE	1	
24	JSM0139	2845562	MINOR KIT	1	
25	JSK0139	N/A	MAJOR KIT	1	ALL INTERNAL PARTS

JPR-CT3200R



■ ENGINE MODEL
C32

■ PUMP P/N
3228594

	JMP	CAT	DESCRIPTION	QTY	REMARK
1	JPR-CT3200R	3228594	SEA WATER PUMP	1	PARTS ONLY
2	BER0065	N/A	BALL BEARING	2	
3	BOL0007	3E9854	HEX BOLT, END COVER	5	
4	BOL0036	1907541	WASHER, END COVER	9	
5	CAMSET0043	3385461	CAM LINER SET	1	ALUMINUM BRONZE 1 PCS
6	COV0057	1566889	END COVER	1	
7	COV0058	2354832	COVER - BEARING	1	
8	8459-01	3228595	IMPELLER	1	
9	MCSSET0029	2127265	MECHANICAL SEAL SET	1	
10	ORG0079	2354828	V-RING	1	
11	ORG0080	1539124	QUAD RING	1	
12	PIN0011	1230495	PIN, CAM LINER	1	
13	RET0056	1558750	OIL SEAL	1	
14	SHA0148	3282560	SHAFT	1	
15	SNP0014	2D5826	SNAP RING	1	
16	SNP0028	2129436	SNAP RING (M-SEAL)	1	
17	WER0030	1539121	WEAR PLATE	1	
18	JSM0140	3047615	MINOR KIT	1	
19	JSK0140	3047616	MAJOR KIT	1	ALL INTERNAL PARTS

CUMMINS ENGINES

SEA(RAW) WATER PUMPS AND PARTS

JPR-C1025



■ **ENGINE MODEL**
4B3.9M, 4BT3.9M, 4BTA3.9M
6B5.9M, 6BT5.9M

■ **PUMP P/N**
3907458, 3912019

JMP	DESCRIPTION	QTY	REMARK
1	JPR-C1025	1	RE-ENGINEERED
1	BER0002	2	
5	CAMSET0020	1	WITH SCREW & PACKING
6	GAK0023	1	
7	GEA0007	1	
8	7300-01	1	
9	KEY0016	1	
10	MCSSET0001	1	
11	ORG0013	1	
12	PBC0092	1	
13	RET0018	1	
14	SHA0051	1	
16	SNP0006	1	
17	SNP0009	1	
18	WER0014	1	
19	JSM0047	1	
20	JSK0047	1	ALL INTERNAL PARTS

JPR-C1040



■ **ENGINE MODEL**
N855M, NT855M, NTA855M

■ **PUMP P/N**
3010336, 3278137

JMP	DESCRIPTION	QTY	REMARK
1	JPR-C1040	1	RE-ENGINEERED
3	BER0010	1	
4	BOL0081	5	
5	CAMSET0005	1	WITH SCREW & PACKING
6	COV0005	1	
7	8001-01	1	
8	MCSSET0003	1	
2	ORG0015	1	
9	RET0007	1	
10	RET0010	1	
11	SHA0019	1	
12	KEY0002	1	
13	WER0003	1	
17	JSM0020	1	
18	JSK0020	1	ALL INTERNAL PARTS

JPR-S7627



■ **ENGINE MODEL**
6CTA8.3M, 6CTA8.3M2

■ **PUMP P/N**
3897194

JMP	DESCRIPTION	QTY	REMARK
1	JPR-S7627	1	RE-ENGINEERED
2	BER0039	2	
3	CAMSET0031	1	WITH SCREW & PACKING
4	COV0036	1	
5	GAK0030	1	
6	7608-01	1	SPLINETYPE
7	MCSSET0014	1	
8	ORG0030	1	
9	SHA0075	1	
10	WER0019	1	
11	GEA0014	1	
12	JSM0002	1	
13	JSK0067	1	ALL INTERNAL PARTS

JPR-S7630



- **ENGINE MODEL**
6BTA5.9M2, 6CT8.3M, 6CTA8.3M
- **PUMP P/N**
3866493, 3897691

JMP	DESCRIPTION	QTY	REMARK
1	JPR-S7630	1	RE-ENGINEERED
2	BER0039	2	
3	BOL0006	3	
4	CAMSET0031	1	WITH SCREW & PACKING
5	COV0036	1	
6	GAK0030	1	
7	7608-01	1	SPLINE TYPE
8	MCSSET0014	1	
9	ORG0030	1	
10	SHA0075	1	
11	WER0019	1	
12	GEA0014	1	
13	JSM0002	1	
14	JSK0067	1	ALL INTERNAL PARTS

JPR-C1900



- **ENGINE MODEL**
KT19M, KTA19M, KTA19M3/M6
KTA19-D(M), KTA19-D(M1)
- **PUMP P/N**
3049158, 3074540

JMP	DESCRIPTION	QTY	REMARK
1	JPR-C1900	1	WITH CLAMP
1-1	JPR-C1900G	1	WITH CLAMP, GEAR
2	BER0037	1	
3	BER0038	1	
4	CLP0100	1	
5	CLP0101	2	
6	IMP002601	1	3074619
7	MCSSET0009	1	
8	ORG0023	2	
9	ORG0024	1	
10	ORG0029	1	
11	PORT001G	2	WITH ORG0023
12	RET0020	1	
13	RET0022	1	
14	RIG0002	1	
15	SHA0054	1	
16	SNP0016	1	
17	SNP0018	1	
18	SPC0003	1	
19	GEA0015	1	
20	JMK0001	1	INCLUDES No.7,10,12,13, 18
21	JSK0122	1	ALL INTERNAL PARTS

JPR-C3800



- **ENGINE MODEL**
KT38M, KTA38M, KTA50M
- **PUMP P/N**
3049158, 3074540

JMP	DESCRIPTION	QTY	REMARK
1	JPR-C3800	1	WITH CLAMP
1-1	JPR-C3800G	1	WITH CLAMP, GEAR
2	BER0037	1	
3	BER0038	1	
4	CLP0100	1	
5	CLP0101	2	
6	IMP002603	1	
7	MCSSET0009	1	
8	ORG0023	2	
9	ORG0024	1	
10	ORG0029	1	
11	PORT001G	2	WITH ORG0023
12	RET0020	1	
13	RET0022	1	
14	RIG0001	1	
15	SHA0054	1	
16	SNP0016	1	
17	SNP0018	1	
18	SPC0003	1	
19	GEA0015	1	
20	JMK0001	1	INCLUDES No.7,10,12,13, 18
21	JSK0123	1	ALL INTERNAL PARTS

JPR-C3800V



■ **ENGINE MODEL**
K38/50, KTA38/50

■ **PUMP P/N**
4314820, 3393018

JMP	DESCRIPTION	QTY	REMARK
1	JPR-C3800V	1	NOT AVAILABLE
2	BER0049	2	
3	CAM0035	1	
4	FLP0002	1	
5	9500K	1	
6	IMP0064	1	
7	KEY0029	1	
8	KEY0030	1	
9	MCSSET0022	1	
10	ORG0003	1	
11	ORG0048	3	
12	ORG0058	1	
13	ORG0064	2	
14	PIN0009	1	
15	RET001301	1	
16	RET0050	1	
17	RIG0004	1	
18	SHA0116	1	
19	SNP0008	1	
20	SNP0014	1	
21	WER0027	2	
22	JSK0117	1	4334438
23	JSK0118	1	4334440

JPR-S7608



■ **ENGINE MODEL**
QSB5.9, QSB6.9

■ **PUMP P/N**
5268375

JMP	DESCRIPTION	QTY	REMARK
1	JPR-S7608	1	RE-ENGINEERED
2	BER0039	2	
3	BOL0006	3	
4	BOL0036	3	
5	CAMSET0031	1	WITH SCREW, PACKING
6	COV0036	1	
7	7608-01	1	
8	MCSSET0014	1	
9	ORG0030	1	
10	SHA0079	1	
11	SNP0011	1	
12	WER0019	1	
13	JSM0002		
14	JSK0068	1	ALL INTERNAL PARTS

JPR-C0700



■ **ENGINE MODEL**
QSB 7.0

■ **PUMP P/N**
2886308

JMP	DESCRIPTION	QTY	REMARK
1	JPR-C0700	1	
2	BER0052	1	
3	BER0061	1	
4	BOL0007	3	
5	BOL0036	7	PUMP BODY (4 PCS)
6	BOL0201	2	
7	COV0059	1	
8	8159-01	1	3972366
9	MCSSET0027	1	
10	ORG0015	1	
11	ORG0055	1	
12	RET0042	1	
13	SHA0149	1	
14	SNP0008	1	
15	SNP0013	1	
16	SPC0012	1	
17	WER0031	1	
18	GEA0032	1	
19	JSM0137	1	
20	JSK0137	1	ALL INTERNAL PARTS

JPR-C0830



■ **ENGINE MODEL**
QSC8.3, QSL9.0

■ **PUMP P/N**
3967246

JMP	DESCRIPTION	QTY	REMARK
1	JPR-C0830	SEA WATER PUMP	1
2	BER0052	BALL BEARING	1
3	BER0061	BALL BEARING	1
4	BOL0007	HEX BOLT, END COVER	3
5	BOL0036	SPRING WASHER, END COVER(3 PCS)	7
6	BOL0201	SET SCREW, WEAR PLATE	2
7	COV0059	END COVER	1
8	8159-01	IMPELLER	1
9	MCSSET0027	MECHANICAL SEAL SET	1
10	ORG0015	O-RING, END COVER	1
11	ORG0055	O-RING, MOUNTING	1
12	RET0042	OIL SEAL	1
13	SHA0149	SHAFT	1
14	SNP0008	SNAP RING	1
15	SNP0013	SNAP RING	1
16	SPC0012	SPACER	1
17	WER0031	WEAR PLATE	1
18	GEA0030	GEAR	1
19	JSM0137	MINOR KIT	1
20	JSK0137	MAJOR KIT	1
			ALL INTERNAL PARTS

JPR-C1100



■ **ENGINE MODEL**
QSM11

■ **PUMP P/N**
3349392, 4929178

JMP	DESCRIPTION	QTY	REMARK
1	JPR-C1100	SEA WATER PUMP	1
2	BER0052	BALL BEARING	2
3	BOL0007	HEX BOLT, END COVER	5
4	BOL0036	SPRING WASHER, END COVER	5
5	CAMSET0032	CAM LINER (1PC ALUMINUM BRONZE)	1
6	COV0038	END COVER	1
7	COV0041	BEARING SHIELD	1
8	8359-01	IMPELLER	1
9	MCSSET0019	MECHANICAL SEAL KIT	1
10	ORG0054	V-RING	1
11	ORG0043	QUAD RING for CAM LINER	2
12	ORG0055	O-RING, MOUNTING ADAPTOR	1
13	PIN0007	PIN, CAM LINER	1
14	RET0042	OIL SEAL	1
15	SHA0093	SHAFT	1
16	SNP0008	SNAP RING	1
17	SNP0013	SNAP RING	1
18	SPC0012	SPACER	1
19	WER0020	WEAR PLATE	1
20	JSM0023	MINOR KIT	1
21	JSK0080	MAJOR KIT	1
			4929178
			4019426
			4019415
			4019409
			4919425
			4933742
			4019427
			4019412
			4019416
			4019428
			4019417
			4019413
			4019419
			4019407
			4019411
			4019410
			4019408
			4930628
			4930629

JPR-C1905



■ **ENGINE MODEL**
QSK19

■ **PUMP P/N**
3866609

JMP	DESCRIPTION	QTY	REMARK
1	JPR-C1905	SEA WATER PUMP	1
2	BER0005	BALL BEARING	1
3	BER0020	BALL BEARING	1
4	BOL0005	HEX BOLT, END COVER	4
5	BOL0035	SPRING WASHER, END COVER	4
6	CAMSET0019	CAM LINER - ALUMINUM BRONZE	1
7	COV001201	END COVER	1
8	9001-01	IMPELLER	1
9	MCSSET0006	MECHANICAL SEAL SET	1
10	ORG0047	O-RING, END COVER	1
11	ORG0003	O-RING	1
12	ORG0048	O-RING, MOUNTING	1
13	PIN0008	DOWEL PIN	1
14	RET001301	OIL SEAL	1
15	SHA0088	SHAFT	1
16	SNP0008	SNAP RING	1
17	SNP0013	SNAP RING	1
18	SPC0012	SPACER	1
19	WER0011	WEAR PLATE	1
20	GEA0015	GEAR	1
21	JSM0022	MINOR KIT	1
22	JSK0069	MAJOR KIT	1
			ALL INTERNAL PARTS
			CUMMINS - PLASTIC

DETROIT DIESEL ENGINES

SEA(RAW) WATER PUMPS AND PARTS

JPR-G6000F



■ **ENGINE MODEL**
353, 453, 471

■ **PUMP P/N**
5145578, 5145577, 5145576
JPR-G6000F includes drive gear and mounting adaptor

No	JMP	DETROIT	DESCRIPTION	QTY	REMARK
1	JPR-G6000F	5145578	SEA WATER PUMP	1	RE-REGINEERED
2	BER0015	5193391	BALL BEARING	1	
3	BOL0080	8927518	SCREW, END COVER	6	
4	CAMSET000301	5196696	CAM SET	1	
5	COV001301	8927516	END COVER	1	
6	GAK0016	8927517	GASKET, END COVER	1	
7	7426-01	5193602	IMPELLER	1	
8	KEY0010	N/A	KEY	1	
9	MCSSET0008	8927526	MECHANICAL SEAL SET	1	
10	RET0005	5195019	OIL SEAL	1	
11	SHA002201	5193675	SHAFT	1	
12	SNP0010	8927523	SNAP RING	1	
13	WER0001	5195753	WEAR PLATE	1	
14	GEO0008	5122648	GEAR	1	
15	JSM0028	N/A	MINOR KIT	1	
16	JSK002301	5199850	MAJOR KIT	1	ALL INTERNAL PARTS

JPR-G6010F



■ **ENGINE MODEL**
271

■ **PUMP P/N**
5197221
JPR-G6010F includes drive gear

No	JMP	DETROIT	DESCRIPTION	QTY	REMARK
1	JPR-G6010F	5145578	SEA WATER PUMP	1	RE-REGINEERED
2	BER0015	5193391	BALL BEARING	1	
3	BOL0080	8927518	SCREW, END COVER	6	
4	CAMSET000301	5196696	CAM SET	1	
5	COV001301	8927516	END COVER	1	
6	GAK0016	8927517	GASKET, END COVER	1	
7	7426-01	5193602	IMPELLER	1	
8	KEY0010	N/A	KEY	1	
9	MCSSET0008	8927526	MECHANICAL SEAL SET	1	
10	RET0005	5195019	OIL SEAL	1	
11	SHA002202	5193675	SHAFT	1	
12	SNP0010	8927523	SNAP RING	1	
13	WER0001	5195753	WEAR PLATE	1	
14	GEO0017	5122648	GEAR	1	
15	JSM0028	N/A	MINOR KIT	1	
16	JSK002302	5199850	MAJOR KIT	1	ALL INTERNAL PARTS

JPR-G6100



■ **ENGINE MODEL**
6V53, 6V71, 8V53

■ **PUMP P/N**
23507971, 5186250, 5107480
23501083, 5115396
JPR-G6100 includes drive gear and mounting adaptor

No	JMP	DETROIT	DESCRIPTION	QTY	REMARK
1	JPR-G6100	23507971	SEA WATER PUMP	1	
2	BER0012	954799	BALL BEARING	1	
3	BOL0005	23504236	SCREW, END COVER	5	
4	CAMSET000501	5193554	CAM SET	1	
5	COV0006	5193555	END COVER	1	
6	8100-01	8924838	IMPELLER	1	
7	GAK0007	5193562	GASKET, END COVER	1	
8	KEY0011	N/A	KEY	1	
9	MCSSET0003	5198419	MECHANICAL SEAL SET	1	
10	RET0011	5195101	OIL SEAL	1	
11	SHA0023	5193552	SHAFT	1	
12	SNP0005	5193569	SNAP RING	1	
13	SNP0013	9415285	SNAP RING	1	
14	WER0009	5193556	WEAR PLATE	1	
15	GEO0004	5193576	GEAR	1	
16	JSM0006	N/A	MINOR KIT	1	
17	JSK0024	5197224	MAJOR KIT	1	ALL INTERNAL PARTS

JPR-G6200



■ **ENGINE MODEL**
6V71TI, 8V71, 12V71

■ **PUMP P/N**
23507971, 5186250, 5107480
23501083, 5115396
JPR-G6200 includes drive gear and mounting adaptor

No	JMP	DETROIT	DESCRIPTION	QTY	REMARK
1	JPR-G6200	23507972	SEA WATER PUMP	1	
2	BER0011	23505479	BALL BEARING	1	
3	BOL0005	23504236	SCREW, END COVER	5	
4	CAMSET0017	5196167	CAM SET	1	
5	COV0006	5193555	END COVER	1	
6	8301-01	8924839	IMPELLER	1	
7	GAK0007	5193562	GASKET, END COVER	1	
8	KEY0014	5197611	KEY	2	
9	MCSSET0003	5198419	MECHANICAL SEAL SET	1	
10	RET0011	5195101	OIL SEAL	1	
11	SHA0024	5196169	SHAFT	1	
12	SNP0014	5169171	SNAP RING	1	
13	WER0009	5193556	WEAR PLATE	1	
14	GEA0005	5196170	GEAR	1	
15	JSM0029	N/A	MINOR KIT	1	
16	JSK0025	5197222	MAJOR KIT	1	ALL INTERNAL PARTS

JPR-G6300



■ **ENGINE MODEL**
8V92TA, 16V92TA

■ **PUMP P/N**
8923363, 23507475, 23507476
23507477, 23507973
JPR-G6300 includes drive gear

No	JMP	DETROIT	DESCRIPTION	QTY	REMARK
1	JPR-G6300	23507973	SEA WATER PUMP	1	
2	BER0005	8927574	BALL BEARING	2	
3	BOL0005	23501649	SCREW, END COVER	6	
4	CAMSET0018	8927571	CAM LINER	1	
5	COV0011	8927569	END COVER	1	
6	GAK0008	23501648	GASKET, END COVER	1	
7	8300-01	8927570	IMPELLER	1	
8	KEY0019	23501664	KEY	1	
9	MCSSET0007	8927573	MECHANICAL SEAL SET	1	
10	ORG0003	23501652	O-RING	1	
11	PIN0002	N/A	DOWEL PIN	2	
12	RET001301	23501651	OIL SEAL	1	
13	SHA0025	8927572	SHAFT	1	
14	SNP0013	23501656	SNAP RING	1	
15	WER0010	8927568	WEAR PLATE	2	
16	GEA0009	N/A	GEAR	1	
17	JSM0005	N/A	MINOR KIT	1	
18	JSK0026	8927566	MAJOR KIT	1	ALL INTERNAL PARTS

JPR-G6400



■ **ENGINE MODEL**
12V71TI, 12V92TA, 16V149TA

■ **PUMP P/N**
8927296, 23525078

No	JMP	DETROIT	DESCRIPTION	QTY	REMARK
1	JPR-G6400	23525078	SEA WATER PUMP	1	
2	BER0005	23502092	BALL BEARING	2	
3	BOL0035	N/A	SPRING WASHER, END COVER	4	
4	BOL010501	23525364	BOLT, END COVER	4	
5	CAMSET0019	23502089	CAM LINER	1	
6	COV001201	23525362	END COVER	1	
8	9000-01	23502086	IMPELLER	1	
9	KEY0019	23506164	KEY, GEAR	1	
10	MCSSET0007	8927573	MECHANICAL SEAL SET	1	SNP0008 INCLUDED
11	ORG0003	23501651	O-RING	1	
12	ORG0047	23511828	O-RING, END COVER	1	
13	PIN0008	23502096	PIN	1	
14	RET001301	23502092	OIL SEAL	1	
15	SHA0025	8927572	SHAFT	1	
17	SNP0013	23501656	SNAP RING	1	
18	WER0011	23502091	WEAR PLATE	1	
19	JSM0004	N/A	MINOR KIT	1	
20	JSK0027	N/A	MAJOR KIT	1	ALL INTERNAL PARTS

JPR-G6500



■ **ENGINE MODEL**
SERIES 60

■ **PUMP P/N**
23535447, 23525200

No	JMP	DETROIT	DESCRIPTION	QTY	REMARK
1	JPR-G6500	23535200	SEA WATER PUMP	1	
2	BER0005	N/A	BALL BEARING	1	
3	BER0020	N/A	BALL BEARING	1	
4	BOL0035	00120385	WASHER, END COVER	4	
5	BOL010501	23525364	BOLT, END COVER	4	
6	CAMSET0019	23502089	CAM LINER	1	
7	COV001201	23525362	END COVER	1	
8	9000-01	23502086	IMPELLER	1	
9	KEY0026	23525369	KEY, WOODRUFF	1	
10	MCSSET0007	8927573	MECHANICAL SEAL SET	1	
11	ORG0047	N/A	O-RING, END COVER	1	
11	PIN0008	23502096	PIN	1	
12	RET001301	23502092	OIL SEAL	1	
13	SHA0091	23525360	SHAFT	1	
14	SNP0013	N/A	SNAP RING	1	
15	WER0011	23502091	WEAR PLATE	1	
16	JSM0004	N/A	MINOR KIT	1	
17	JSK0079	N/A	MAJOR KIT	1	ALL INTERNAL PARTS



JOHN DEERE ENGINES

SEA(RAW) WATER PUMPS AND PARTS

JPR-JD25UH



■ **ENGINE MODEL**
4039, 4045, 6068 SERIES

■ **PUMP P/N**
RE535944

No	JMP	DESCRIPTION	QTY	REMARK
1	JPR-JD25UH	SEA WATER PUMP	1	RE-ENGINEERED
2	BER0045	BALL BEARING	2	
3	BOL0080	END COVER SCREW	6	
4	CAMSET000301	CAM KIT	1	WITH SCREW, PACKING
5	COV0003	END COVER	1	
6	7400-01	IMPELLER	1	RE526661
7	MCSSET0008	MECHANICAL SEAL SET	1	
8	ORG0013	O-RING	1	
9	RET0040	OIL SEAL	1	
10	SHA0087	SHAFT	1	
11	SNP0006	SNAP RING	1	
12	SNP0009	SNAP RING	1	
13	WER0001	WEAR PLATE	1	
14	JSM0024	MINOR KIT	1	
15	JSK0076	MAJOR KIT	1	ALL INTERNAL PARTS

JPR-S7633



■ **ENGINE MODEL**
6068SFM50

■ **PUMP P/N**
RE515657

No	JMP	DESCRIPTION	QTY	REMARK
1	JPR-S7633	SEA WATER PUMP	1	RE-ENGINEERED
2	BER0039	BEARING	2	
3	BOL0006	HEX BOLT	3	
4	BOL0036	SPRING WASHER	3	
5	CAMSET0031	CAM SET	1	WITH SCREW, PACKING
6	COV0036	COVER	1	
7	7608-01	IMPELLER	1	RE49896 IS JMP 7600-01
8	KEY0031	KEY	1	
9	MCSSET0014	MECHANICAL SEAL SET	1	
10	ORG0030	O-RING, END COVER	1	
11	RET0055	RETAINER	1	
12	SHA0145	SHAFT	1	
13	SNP000301	SNAP RING	1	
14	WER0019	WEAR PLATE	1	
15	JSM0002	MINOR KIT	1	
16	JSK0133	MAJOR KIT	1	ALL INTERNAL PARTS

JPR-S7619



■ **ENGINE MODEL**
6067, 6068, 6081 SERIES

■ **PUMP P/N**
RE45458, RE517226

No	JMP	DESCRIPTION	QTY	REMARK
1	JPR-S7619	SEA WATER PUMP	1	RE-ENGINEERED
2	BER0039	BEARING	2	
3	BOL0006	BOLT, END COVER	3	
4	BOL0036	SPRING WASHER	3	
5	CAMSET0031	CAM SET	1	WITH SCREW, PACKING
6	COV0036	END COVER	1	
7	7608-01	IMPELLER	1	RE49896 IS JMP 7600-01
8	MCSSET0014	MECHANICAL SEAL SET	1	
9	ORG0030	O-RING, END COVER	1	
10	RET0035	OIL SEAL, ADAPTOR	1	
11	SHA0084	SHAFT	1	
12	WER0019	PLATE, WEAR	1	
13	JSM0002	MINOR KIT	1	
14	JSK0077	MAJOR KIT	1	ALL INTERNAL PARTS

JPR-JD50LF



■ **ENGINE MODEL**
DONG-A 6125 SERIES

■ **PUMP P/N**
N/A

No	JMP	DESCRIPTION	QTY	REMARK
1	JPR-JD50LF	SEA WATER PUMP	1	DONG-A MARINE 6125
1-1	JPR-JD50LF2	SEA WATER PUMP	1	NANNI 48101087
2	BER0005	BEARING	2	
3	BOL0081	SCREW, END COVER	5	
4	CAMSET0016	CAM SET	1	
5	COV0005	END COVER	1	
6	8300-1	IMPELLER	1	
7	MCSSET0003	MECHANICAL SEAL SET	1	
8	ORG0015	O-RING, END COVER	1	
9	RET0012	OIL SEAL	1	
10	SHA0058	SHAFT	1	
11	SLI0003	SLINGER	1	
12	SNP0005	SNAP RING	1	
13	SNP0013	SNAP RING	1	
14	WER0003	WEAR PLATE	1	
15	JSM0025	MINOR KIT	1	
16	JSK0056	MAJOR KIT	1	ALL INTERNAL PARTS
16-1	JSK005601	MAJOR KIT (JPR-JD50LF2)	1	ALL INTERNAL PARTS

JPR-JD60IF



■ **ENGINE MODEL**
6125, 6135 SERIES

■ **PUMP P/N**
RE530689, RE536016, RE524510,
RE530872

No	JMP	DESCRIPTION	QTY	REMARK
1	JPR-JD60IF	SEA WATER PUMP	1	ELBOWS NOT INCLUDED
1-1	JPR-JD60IF2	SEA WATER PUMP	1	ELBOWS NOT INCLUDED
2	BER0052	BALL BEARING	2	
3	BOL0007	HEX BOLT, END COVER	5	
4	BOL0036	SPRING WASHER, END COVER	5	
5	CAMSET0032	CAM LINER SET	1	ALUMINUM BRONZE 1 PC
6	COV0038	END COVER	1	
7	COV0041	BEARING SHIELD	1	
8	8350-01	IMPELLER	1	RE524511(JPR-JD60IF)
8-1	8359-01	IMPELLER	1	DZ108622(JPR-JD60IF2)
9	MCSSET0019	MECHANICAL SEAL SET	1	
10	ORG0043	QUAD RING, CAM LINER	2	
11	ORG0054	V-RING	1	
12	ORG0055	O-RING, MOUNTING	1	
13	PIN0007	PIN, CAM LINER	1	
14	RET0042	OIL SEAL	1	
15	SHA0096	SHAFT	1	JPR-JD60IF
15-1	SHA0093	SHAFT	1	JPR-JD60IF2
16	SNP0008	SNAP RING (M-SEAL)	1	
17	SNP0013	SNAP RING (BEARING)	1	
18	WER0020	WEAR PLATE	1	
19	JSM0027	MINOR KIT	1	RE530873(JPR-JD60IF)
19-1	JSM0023	MINOR KIT	1	JPR-JD60IF2
20	JSK0084	MAJOR KIT	1	RE530879, ALL INTERNAL PARTS
20-1	JSK0080	MAJOR KIT	1	JPR-JD60IF2, ALL INTERNAL PARTS

JPR-JD60IF2

■ **ENGINE MODEL**
6090, 6125, 6135 SERIES

■ **PUMP P/N**
DZ108620

JPR-JD60LF(2)



■ **ENGINE MODEL**
DONG-A MARINE 6125,
6135 SERIES

■ **PUMP P/N**
N/A

No	JMP	DESCRIPTION	QTY	REMARK
1	JPR-JD60LF	SEA WATER PUMP	1	ELBOWS NOT INCLUDED
1-1	JPR-JD60LF2	SEA WATER PUMP	1	
2	BER0049	BALL BEARING	2	
3	BOL0006	HEX BOLT, END COVER	5	
4	BOL0036	SPRING WASHER, END COVER	5	
5	CAMSET0032	CAM LINER SET	1	
6	COV0038	END COVER	1	
7	COV0041	BEARING SHIELD	1	
8	8350-01	IMPELLER / RE524511	1	JPR-JD60LF
8-1	8359-01	IMPELLER	1	JPR-JD60LF2
9	MCSSET0003	MECHANICAL SEAL SET	1	
10	ORG0043	QUAD RING for CAM LINER	2	
11	PIN0007	PIN, CAM LINER	1	
12	RET0036	OIL SEAL	1	
13	SHA0070	SHAFT	1	JPR-JD60LF
13-1	SHA007001	SHAFT	1	JPR-JD60LF2
14	SNP0008	SNAP RING (M-SEAL)	1	
15	SNP0014	SNAP RING (BEARING)	1	
16	WER0020	WEAR PLATE	1	
17	JSM0026	MINOR KIT	1	JPR-JD60LF
17-1	JSM002601	MINOR KIT	1	JPR-JD60LF2
18	JSK0078	MAJOR KIT	1	JPR-JD60LF, ALL INTERNAL PARTS
18-1	JSK007801	MAJOR KIT	1	JPR-JD60LF2, ALL INTERNAL PARTS

mitsubishi engines

SEA(RAW) WATER PUMPS AND PARTS

JPR-MD65LF



■ **ENGINE MODEL**
S6R, S6R2

■ **PUMP P/N**
37553-18102, 37553-28100,
37555-101N0

No	JMP	DESCRIPTION	QTY	REMARK
1	JPR-MD65LF	SEA WATER PUMP	1	
1-1	JPR-MD65LFA	SEA WATER PUMP	1	WITH GEA0010
1-2	JPR-MD65LFB	SEA WATER PUMP	1	WITH GEA0026
1-3	JPR-MD65LFR	SEA WATER PUMP	1	WITH GEA0019
2	BER0016	BALL BEARING	1	
3	BER0028	BALL BEARING	1	
4	BOL0006	BOLT	8	
5	BOL002101	NUT, GEAR	1	
6	BOL0036	WASHER	6	
7	BOL0188	WASHER, GEAR	1	
8	CAMSET000901	CAM	1	WITH BOLT, PACKING
9	COV0009	COVER	1	
10	GAK0002	GASKET	1	
11	9100-01	IMPELLER	1	
12	KEY0018	KEY	1	
13	MCSSET0011	M-SEAL	1	
14	ORG0012	O-RING	2	
15	ORG0021	O-RING	1	
16	RET0027	RETAINER	1	
17	SHA001401	SHAFT	1	
18	SNP0018	SNAP RING	1	
19	WER0005	WEAR PLATE	1	
21	JSM0021	MINOR KIT	1	
22	JSK0064	MAJOR KIT	1	ALL INTERNAL PARTS
23	GEA0010	GEAR, MHI 42763-00200	1	S6A3
24	GEA0026	GEAR, MHI 34A53-01200	1	S6B5
25	GEA0019	GEAR, MHI F2330-22005	1	S6R, S6R2

JPR-ME5000



■ **ENGINE MODEL**
S6A, S6B, S6R, S6R2
KEEL COOLING APPLICATION

■ **PUMP P/N**

No	JMP	DESCRIPTION	QTY	REMARK
1	JPR-ME5000	SEA WATER PUMP	1	
1-1	JPR-ME5000A	SEA WATER PUMP	1	WITH GEA0010
1-2	JPR-ME5000B	SEA WATER PUMP	1	WITH GEA0026
1-3	JPR-ME5000R	SEA WATER PUMP	1	WITH GEA0019
2	BER0024	BEARING	2	
3	BOL0166	HEX NUT, IMPELLER	1	
4	BOL0188	WASHER, GEAR	1	
5	GAK0066	GASKET	1	
6	IMP0062	IMPELLER	1	
7	KEY0018	KEY	1	
8	KEY0031	KEY, WOODRUFF	1	
9	MCSSET0004	MECHANICAL SEAL SET	1	
10	ORG0021	O-RING	1	
11	ORG0034	O-RING	1	
12	PORT004	PLATE	1	
13	RET001301	OIL SEAL	1	
14	SHA0111	SHAFT	1	
15	SLI0003	SLINGER	1	
16	SNP0014	SNAP RING	1	
17	SPC0028	SEAL SPACER	1	
18	GEA0010	GEAR, MHI 42763-00200	1	S6A3
19	GEA0026	GEAR, MHI 34A53-01200	1	S6B5
20	GEA0019	GEAR, MHI F2330-22005	1	S6R, S6R2
21	JSM0109	MINOR KIT	1	
22	JSK0109	MAJOR KIT	1	ALL INTERNAL PARTS

SCANIA ENGINES

SEA(RAW) WATER PUMPS AND PARTS

JPR-SC50IF



- **ENGINE MODEL**
D9, DI12, DI13, DI16 SERIES
- **PUMP P/N**
1785018

JPR-SC50IF2

- **ENGINE MODEL**
D13 GENSET
- **PUMP P/N**

No	JMP	DESCRIPTION	QTY	REMARK
1	JPR-SC50IF	SEA WATER PUMP	1	RE-REGINEERED
1-1	JPR-SC50IF2	SEA WATER PUMP	1	RE-REGINEERED
2	BER0011	BALL BEARING	1	
3	BOL0081	SCREW for END COVER	5	
4	CAMSET0016	CAM SET	1	WITH SCREW, PACKING
5	COV0005	END COVER	1	
6	8301-01	IMPELLER	1	
7	MCSSET0003	MECHANICAL SEAL SET	1	
8	ORG0015	O-RING for END COVER	1	
9	KEY0036	KEY, DRIVE	1	JPR-SC50IF2
10	RET0012	OIL SEAL	1	
11	SHA0083	SHAFT	1	JPR-SC50IF
11-1	SHA008301	SHAFT	1	JPR-SC50IF2
12	SLI0003	SLINGER	1	
13	SNP0005	SNAP RING	1	
14	SNP0014	SNAP RING	1	
15	WER0003	WEAR PLATE	1	
16	JSM0033	MINOR KIT	1	JPR-SC50IF(2)
17	JSK0028	MAJOR KIT (JPR-SC50IF)	1	ALL INTERNAL PARTS
17-1	JSK002801	MAJOR KIT (JPR-SC50IF2)	1	ALL INTERNAL PARTS

JPR-SC5000B



- **ENGINE MODEL**
D9, DI12, DI13, DI16 SERIES
KEEL COOLING APPLICATION
- **PUMP P/N**
1934597

No	JMP	DESCRIPTION	QTY	REMARK
1	JPR-SC5000B	SEA WATER PUMP		NOT AVAILABLE
2	BER0024	BEARING	1	
3	BER0057	BEARING	1	
4	BOL0038	SPRING WASHER	3	
5	BOL0114	HEX BOLT	2	
6	BOL0115	NYLON NUT	2	
7	BOL0151	HEX BOLT	2	
8	BOL0155	LOCK WASHER	1	
9	BOL0203	SLOTTED NUT	1	
10	BOL0204	HEX BOLT	3	
11	BOL0205	NYLON NUT	2	
12	IMP0073	IMPELLER	1	
13	MCSSET0010	MECHANICAL SEAL	1	
14	NIP0008	PLUG	1	
15	ORG002901	O-RING	1	
16	PORT002	PORT PLATE	2	
17	RET0023	OIL SEAL	1	
18	RIG0003	RING	1	
19	SHA0155	SHAFT	1	
20	SNP0014	SNAP RING	2	
21	SPC0004	SEAL SPACER	1	
22	SPC0026	COLLAR SEAL	1	

NORTHERN LIGHTS ENGINES

SEA(RAW) WATER PUMPS AND PARTS

JPR-NL08IH



■ ENGINE MODEL
M673 SERIES

■ PUMP P/N
25-12007

No	JMP	DESCRIPTION	QTY	REMARK
1	JPR-NL08IH	SEA WATER PUMP	1	RE-ENGINEERED
2	BER0053	BALL BEARING	2	
3	BOL0144	SCREW, END COVER	6	
4	COV0042	END COVER	1	
5	7070-01	IMPELLER	1	
6	MCSSET0018	MECHANICAL SEAL SET	1	
7	ORG0052	O-RING, END COVER	1	
8	ORG0056	O-RING, MOUNTING	1	
9	RET0043	OIL SEAL	1	
10	SHA0094	SHAFT	1	
11	SNP0025	SNAP RING (BEARING)	1	
12	JSM0088	MINOR KIT	1	
13	JSK0081	MAJOR KIT	1	

JPR-NL10IP



■ ENGINE MODEL M843, M844 SERIES

■ PUMP P/N 25-12057

No	JMP	DESCRIPTION	QTY	REMARK
1	JPR-NL10IP	SEA WATER PUMP	1	RE-ENGINEERED
1-1	JPR-NL10IP2	SEA WATER PUMP	1	RE-ENGINEERED
2	BER0050	BALL BEARING	2	
3	BOL0080	SCREW, END COVER	6	
4	CAMSET0033	CAM KIT	1	With SCREW, GASKET
5	COV0003	END COVER	1	
6	7100-01	IMPELLER	1	
7	MCSSET0008	MECHANICAL SEAL SET	1	
8	ORG0013	O-RING, END COVER	1	
9	ORG0044	O-RING	1	
10	RET0038	OIL SEAL	1	
11	SHA0085	SHAFT	1	JPR-NL10IP
11-1	SHA0086	SHAFT	1	JPR-NL10IP2
12	SNP0006	SNAP RING (M-SEAL)	1	
13	SNP0009	SNAP RING (BEARING)	1	
14	WER0006	WEAR PLATE	1	
15	JSM0090	MINOR KIT	1	JPR-NL10IP(2)
16	JSK0073	MAJOR KIT (JPR-NL10IP)	1	ALL INTERNAL PARTS
16-1	JSK0074	MAJOR KIT (JPR-NL10IP2)	1	ALL INTERNAL PARTS

JPR-NL10IP2



■ ENGINE MODEL M864, M984 SERIES

■ PUMP P/N 25-15405

No	JMP	DESCRIPTION	QTY	REMARK
1	JPR-NL20IP	SEA WATER PUMP	1	RE-ENGINEERED
2	BER0035	BALL BEARING	2	
3	BOL0080	SCREW, END COVER	4	
4	CAMSET000301	CAM SET	1	WITH SCREW, GASKET
5	COV0047	END COVER	1	
6	7400-01	IMPELLER	1	
7	MCSSET0008	MECHANICAL SEAL SET	1	
8	ORG0013	O-RING, END COVER	1	
9	RET0047	OIL SEAL	1	
10	SHA0105	SHAFT	1	
11	SNP0006	SNAP RING (M-SEAL)	1	
12	SNP0010	SNAP RING (BEARING)	1	
13	WER0001	WEAR PLATE	1	
14	JSM0078	MINOR KIT	1	
15	JSK0097	MAJOR KIT	1	ALL INTERNAL PARTS

JPR-NL20IP



■ ENGINE MODEL
M944 SERIES

■ PUMP P/N
25-11202

VOLVO PENTA ENGINES

SEA(RAW) WATER PUMPS AND PARTS

JPR-VP2799G



■ **ENGINE MODEL**
4.3/5.0GL, 4.3/5.0/5.7GXi, 5.7Gi,
V6-200/225, V8-225/270/300/320

■ **PUMP P/N**
21212799

No	JMP	VOLVO PENTA	DESCRIPTION	QTY	REMARK
1	JPR-VP2799G	21212799	SEA WATER PUMP	1	
2	BOL0192	21951332	SCREW, PUMP BODY	4	
3	7136-01	21213664	IMPELLER	1	
4	ORG000101		O-RING, SCREW	4	
5	ORG0052	3858938	O-RING, IMPELLER	1	
6	PBC0247		PUMP BODY	1	
7	RET0013	827247	LIP SEAL	1	
8	SPC0033		SUPPORT RUBBER BUSH	1	
9	PUK0157	N/A	DRIVE ASSY	1	PULLEY, SHAFT, BEARING, SNAP RING, BEARING HOUSING

JPR-VP2800G



■ **ENGINE MODEL**
8.1Gi, 8.1IPS

■ **PUMP P/N**
21212800

No	JMP	VOLVO PENTA	DESCRIPTION	QTY	REMARK
1	JPR-VP2800G	21212800	SEA WATER PUMP	1	
2	BOL0192	21951332	SCREW, PUMP BODY	4	
3	7136-01	21213664	IMPELLER	1	
4	ORG000101		O-RING, SCREW	4	
5	ORG0052	3858938	O-RING, IMPELLER	1	
6	PBC0247		PUMP BODY	1	
7	RET0013	827247	LIP SEAL	1	
8	SPC0033		SUPPORT RUBBER BUSH	1	
9	PUK0158	N/A	DRIVE ASSY	1	PULLEY, SHAFT, BEARING, SNAP RING, BEARING HOUSING

JPR-VP5090G



■ **ENGINE MODEL**
4.3/5.0/5.7GL, 4.3/5.0/5.7GS,
4.3/5.0Gi,

■ **PUMP P/N**
21255090

No	JMP	VOLVO PENTA	DESCRIPTION	QTY	REMARK
1	JPR-VP5090G	21255090	SEA WATER PUMP	1	
2	BOL0192	21951332	SCREW, PUMP BODY	4	
3	7136-01	21213664	IMPELLER	1	
4	ORG000101		O-RING, SCREW	4	
5	ORG0052	3858938	O-RING, IMPELLER	1	
6	PBC0247		PUMP BODY	1	
7	RET0013	827247	LIP SEAL	1	
8	SPC0033		SUPPORT RUBBER BUSH	1	
9	PUK0159	N/A	DRIVE ASSY	1	PULLEY, SHAFT, BEARING, SNAP RING, BEARING HOUSING

JPR-VP4596G



- **ENGINE MODEL**
4.3/5.0/5.7GL, 4.3/5.0/5.7GS, 4.3/5.0Gi
- **PUMP P/N** 21214596

No	JMP	VOLVO PENTA	DESCRIPTION	QTY	REMARK
1	JPR-VP4596G	21214596	SEA WATER PUMP	1	
2	BOL0182	22125080	SCREW, PUMP BODY	4	
3	7100-01	21951348	IMPELLER	1	
4	ORG0052	3858938	O-RING, IMPELLER	1	
5	PBC0246	22125080	PUMP BODY	1	
6	RET0013	827247	LIP SEAL	1	
7	PUK0154	N/A	DRIVE ASSY	1	PULLEY, SHAFT, BEARING, SNAP RING, BEARING HOUSING

JPR-VP4599G



- **ENGINE MODEL**
3.0GS, 4.3/5.0GL, 4.3/5.0Gi, 4.3/5.0GXi, 5.7GS, 5.7Gi
- **PUMP P/N** 21214599

No	JMP	VOLVO PENTA	DESCRIPTION	QTY	REMARK
1	JPR-VP4599G	21214599	SEA WATER PUMP	1	
2	BOL0182	22125080	SCREW, PUMP BODY	4	
3	7100-01	21951348	IMPELLER	1	
4	ORG0052	3858938	O-RING, IMPELLER	1	
5	PBC0246	22125080	PUMP BODY	1	
6	RET0013	827247	LIP SEAL	1	
7	PUK0155	N/A	DRIVE ASSY	1	PULLEY, SHAFT, BEARING, SNAP RING, BEARING HOUSING

JPR-VP4601G



- **ENGINE MODEL**
8.1Gi, DPX375/420
- **PUMP P/N** 21214601

No	JMP	VOLVO PENTA	DESCRIPTION	QTY	REMARK
1	JPR-VP4601G	21214601	SEA WATER PUMP	1	
2	BOL0182	22125080	SCREW, PUMP BODY	4	
3	7100-01	21951348	IMPELLER	1	
4	ORG0052	3858938	O-RING, IMPELLER	1	
5	PBC0246	22125080	PUMP BODY	1	
6	RET0013	827247	LIP SEAL	1	
7	PUK0156	N/A	DRIVE ASSY	1	PULLEY, SHAFT, BEARING, SNAP RING, BEARING HOUSING

JPR-V1000



- **ENGINE MODEL**
AD31, MD31, AD41, KA(M)D42, 43, 44 SERIES
- **PUMP P/N**
860629, 3581588, 3583115

No	JMP	VOLVO PENTA	DESCRIPTION	QTY	REMARK
1	JPR-V1000	3583115	SEA WATER PUMP	1	RE-ENGINEERED
2	BER0029	11010	BALL BEARING	1	
3	BOL0080	841693	SCREW, END COVER	6	
4	CAMSET000301	N/A	CAM SET	1	WITH SCREW, PACKING
5	COV000301	860751	END COVER	1	
6	7400-01	21951356	IMPELLER	1	
7	MCSSET0008	827247	MECHANICAL SEAL	1	
8	ORG0013	3581618	O-RING, END COVER	1	
9	ORG0044	960166	O-RING, SLINGER	1	
10	RET0044	827247	OIL SEAL	2	
11	SHA0097	21951457	SHAFT	1	
12	SNP0002	N/A	SNAP RING (SMALL)	1	
13	SNP0009	914523	SNAP RING (LARGE)	1	
14	SPC0019	844580	SPACER	1	
15	WER0001	N/A	WEAR PLATE	1	
16	JSM0030	N/A	MINOR KIT	1	
17	JSK0085	N/A	MAJOR KIT	1	ALL INTERNAL PARTS

JPR-V2000



■ **ENGINE MODEL**
T(A)MD 100, 120, 121, 122 SERIES

■ **PUMP P/N**
822787

No	JMP	VOLVO PENTA	DESCRIPTION	QTY	REMARK
1	JPR-V2000	822787	SEA WATER PUMP	1	
2	BER0005	11013	BALL BEARING	2	
3	BOL0099	959931	SCREW, END COVER	5	
4	CAMSET000502	849321	CAM SET	1	WITH SCREW, PACKING
5	COV0006	863497	END COVER	1	
6	GAK0007	3829314	GASKET, END COVER	1	OLD, 825728
7	8100-01	21730344	IMPELLER	1	OLD, 875736
8	KEY0012	942406	KEY, WOODRUFF	1	
9	MCSSET0003	822767	MECHANICAL SEAL SET	1	
10	RET001301	825737	OIL SEAL	1	
11	SHA0027	822789	SHAFT	1	
12	SLI0003	826234	SLINGER	1	
13	SNP0013	825735	SNAP RING	1	
14	WER0009	826230	WEAR PLATE	1	
15	JSM0007	N/A	MINOR KIT	1	
16	JSK0029	N/A	MAJOR KIT	1	ALL INTERNAL PARTS

JPR-V3000



■ **ENGINE MODEL**
TAMD 102, 103, 120, 122

■ **PUMP P/N**
3829313 / 3829312

No	JMP	VOLVO PENTA	DESCRIPTION	QTY	REMARK
1	JPR-V3000	3829313, 3829312	SEA WATER PUMP	1	
2	BER0005	11013	BALL BEARING	2	
3	BOL0099	959931	SCREW, END COVER	5	
4	CAMSET0011	845968	CAMSET	1	WITH SCREW, PACKING
5	COV0006	847228	END COVER	1	
6	GAK0007	3829314	GASKET, END COVER	1	
7	8301-01	875814	IMPELLER	1	
8	KEY0012	942406	KEY, WOODRUFF	1	
9	MCSSET0003	3829315	MECHANICAL SEAL SET	1	OLD, 812968
10	RET001301	845795	OIL SEAL	1	
11	SHA0028	845970	SHAFT	1	
12	SLI0003	812964	SLINGER	1	
13	SNP0013	825735	SNAP RING	1	
14	WER0009	826230	WEAR PLATE	1	
15	JSM0031	N/A	MINOR KIT	1	
16	JSK0030	N/A	MAJOR KIT	1	ALL INTERNAL PARTS

JPR-V5000



■ **ENGINE MODEL**
TAMD 162, 163, 165

■ **PUMP P/N**
3825493, 3837935

No	JMP	VOLVO PENTA	DESCRIPTION	QTY	REMARK
1	JPR-V5000	3837935	SEA WATER PUMP	1	RE-ENGINEERED
2	BER0005	11013	BALL BEARING	1	
3	BER0019	3826173	ROLLER BEARING	1	
4	BER0020	3839505	ROLLER BEARING	1	
5	BOL0081	21951340 (Kit)	SCREW, END COVER	5	
6	CAMSET0011	863496	CAM SET	1	WITH SCREW, PACKING
7	COV0005	N/A	END COVER	1	JPR-V50000
8	8301-01	21951364	IMPELLER	1	
9	MCSSET0006	3829315	MECHANICAL SEAL SET	1	
10	NIP0005	N/A	PLUG, RING	1	
11	NIP0014	N/A	PLUG, DRAIN	2	
12	ORG0015	N/A	O-RING, END COVER	1	JPR-V50000
13	RET0014	825737	OIL SEAL	1	
14	SHA0049	3837936	SHAFT	1	
15	SLI0003	812964	SLINGER	1	
16	SNP0005	3826181	SNAP RING (SMALL)	1	
17	SNP0008	943468	SNAP RING (MECHANICAL SEAL)	1	
18	SNP0013	N/A	SNAP RING (LARGE)	1	
19	WER0009	826230	WEAR PLATE	1	
20	JSM0032	N/A	MINOR KIT	1	
21	JSK0048	N/A	MAJOR KIT	1	ALL INTERNAL PARTS

JPR-VP0010DA

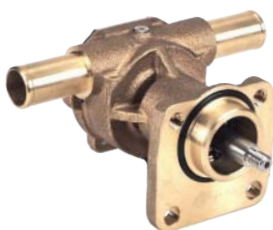

■ ENGINE MODEL
D1(A)

■ PUMP P/N
3593654

No	JMP	VOLVO PENTA	DESCRIPTION	QTY	REMARK
1	JPR-VP0010DA	3593654	SEA WATER PUMP	1	
2	BER0048	181717	BALL BEARING	2	
3	BOL0144	840384	SCREW, END COVER	6	
4	CAMSET0034	827009	CAM SET	1	
5	COV0048	840386	END COVER (STS)	1	
6	GAK0052	840385	GASKET, END COVER	1	
7	7051-01	3593659	IMPELLER	1	
8	ORG0053	925055	O-RING, SLINGER	1	
9	ORG0056	3580063	O-RING, MOUNTING	1	
10	RET0048	833996	LIP SEAL	2	
11	SHA0107	N/A	SHAFT	1	
12	SNP0024	914515	SNAP RING (LARGE)	1	
13	SNP0027	914446	SANP RING (SMALL)	1	
14	SPC0027	3581367	SPACER SLEEVE	1	
15	SPC0029	859101	WASHER	1	
16	JSM0072	N/A	MINOR KIT	1	
17	JSK0091	N/A	MAJOR KIT	1	ALL INTERNAL PARTS

JPR-VP0010DB



■ ENGINE MODEL
D1(B)

■ PUMP P/N
3593655

No	JMP	VOLVO PENTA	DESCRIPTION	QTY	REMARK
1	JPR-VP0010DB	3593655	SEA WATER PUMP	1	
2	BER0048	181717	BALL BEARING	2	
3	BOL0144	840384	SCREW, END COVER	6	
4	CAMSET0035		CAM SET	1	
5	COV0048	840386	END COVER (STS)	1	
6	GAK0052	840385	GASKET, END COVER	1	
7	7051-01	3593659	IMPELLER	1	
8	ORG0053	925055	O-RING, SLINGER	1	
9	ORG0056	3580063	O-RING (MOUNTING)	1	
10	RET0048	833996	LIP SEAL	2	
11	SHA0108	N/A	SHAFT	1	
12	SNP0024	914515	SNAP RING(LARGE)	1	
13	SNP0027	914446	SANP RING(SMALL)	1	
14	SPC0027	3581367	SPACER SLEEVE	1	
15	SPC0029	859101	WASHER	1	
16	JSM0073	N/A	MINOR KIT	1	
17	JSK0092	N/A	MAJOR KIT	1	ALL INTERNAL PARTS

JPR-VP0020D



■ ENGINE MODEL
D2

■ PUMP P/N
3583089

No	JMP	VOLVO PENTA	DESCRIPTION	QTY	REMARK
1	JPR-VP0020D	3583089	SEA WATER PUMP	1	
2	BER0046	860202	BALL BEARING	2	
3	BOL0163	3885957	SCREW, END COVER	4	
4	BOL0164	3583988	WASHER	1	
5	COV0049	3583985	END COVER (STS)	1	
6	7100-01	21951346	IMPELLER		OLD 877440
7	ORG0044	925057	O-RING, SLINGER	1	
8	ORG0061	3583809	O-RING, END COVER	1	
9	RET0013	3583987	LIP SEAL (STS)	1	
10	RET0049	3583992	OIL SEAL	1	
11	SHA0109	N/A	SHAFT	1	
12	SNP0002	914451	SNAP RING (SMALL)	1	
13	SNP0022	3583991	SNAP RING (LARGE)	1	
14	WER0024	3583990	WEAR PLATE (STS)	1	
15	JSM0074	N/A	MINOR KIT	1	
16	JSK0093	N/A	MAJOR KIT	1	ALL INTERNAL PARTS

JPR-VP0030DA



■ ENGINE MODEL
D3

■ PUMP P/N
21141637

No	JMP	VOLVO PENTA	DESCRIPTION	QTY	REMARK
1	JPR-VP0030DA	21141637	SEA WATER PUMP	1	
2	BER0039	N/A	BALL BEARING	1	
3	BER0045	181800	BALL BEARING	1	
4	BOL0163	21346724	SCREWS, END COVER	4	
5	COV0049	3583985	END COVER	1	
6	7136-01	21951352	IMPELLER	1	OLD, 3593660, 21381693
7	ORG0061	3583809	O-RING FOR END COVER	1	
8	ORG0062	3584349	O-RING, SLINGER	1	
9	RET0013	827247	LIP SEAL	1	
10	SHA0112	N/A	SHAFT	1	
11	JSM0075	N/A	MINOR KIT	1	
12	JSK0094	N/A	MAJOR KIT	1	ALL INTERNAL PARTS

JPR-VP0030DB



■ ENGINE MODEL
D3

■ PUMP P/N
21379102

No	JMP	VOLVO PENTA	DESCRIPTION	QTY	REMARK
1	JPR-VP0030DB	21379102	SEA WATER PUMP	1	
2	BER0045	181800	BALL BEARING	2	
3	BOL0164	3583988	WASHER, MECHANICAL SEAL	1	
4	BOL0176	N/A	HEX SOCKET SCREW	3	
5	7136-01	21951352	IMPELLER	1	
6	MCSSET0016	N/A	MECHANICAL SEAL SET	1	
7	NIP0016	982363	PLUG	1	
8	ORG0044	960166	O-RING, SLINGER	1	
9	ORG0069	N/A	O-RING , BC/IC	1	
10	SHA0119	N/A	SHAFT	1	
11	SNP0006	809444	SNAP RING (SMALL)	1	
12	SNP0009	914523	SNAP RING, LARGE	1	
13	JSM0081	N/A	MINOR KIT	1	
14	JSK0100	N/A	MAJOR KIT	1	ALL INTERNAL PARTS

JPR-VP0040DA



■ ENGINE MODEL
D4

■ PUMP P/N
3584062

No	JMP	VOLVO PENTA	DESCRIPTION	QTY	REMARK
1	JPR-VP0040DA	3584062	SEA WATER PUMP	1	
2	BER0052	21422639	BALL BEARING	2	
3	BOL0081	3583604	SCREW, END COVER	6	
4	CAMSET0039	3583612	CAM SET	1	
5	7426-01	3588475	IMPELLER	1	
6	ORG0071	3583611	O-RING, END COVER	1	
7	KEY0032	888386	KEY, WOODRUFF	1	
8	MCSSET0023	3583609	MECHANICAL SEAL SET	1	
9	PBC0216	3583613	END COVER	1	
10	SHA0123	21418999	SHAFT	1	
11	SNP0004	804709	SNAP RING, PULLEY	1	
12	SNP0006	809444	SNAP RING, MECH SEAL	1	
13	SNP0013	21422641	SNAP RING (LARGE)	1	
14	SPC0019	888388	SHIM, MECHANICAL SEAL	1	
15	WER0029	807589	WEAR PLATE	1	
16	JSM0101	N/A	MINOR KIT	1	
17	JSK0101	N/A	MAJOR KIT	1	ALL INTERNAL PARTS

JPR-VP0040DB



■ ENGINE MODEL
D4

■ PUMP P/N
21419374

No	JMP	VOLVO PENTA	DESCRIPTION	QTY	REMARK
1	JPR-VP0040DB	21419374	SEA WATER PUMP	1	
2	BER0058	21422638	BALL BEARING	2	
3	BOL0163	21346724	SCREW, END COVER	6	
4	COV0051	3581617	END COVER	1	
5	7400-01	21422647	IMPELLER	1	OLD, 3841697, 21422647
6	MCSSET0016	21379134	MECHANICAL SEAL SET	1	
7	ORG0032	3581618	O-RING, END COVER	1	
8	ORG0044	960166	O-RING, SLINGER	1	
9	SHA0115	21422634	SHAFT	1	
10	SNP0006	809444	SNAP RING, MECH SEAL	1	
11	SNP0010	21422642	SNAP RING (LARGE)	1	
12	JSM0080	N/A	MINOR KIT	1	
13	JSK0098	N/A	MAJOR KIT	1	ALL INTERNAL PARTS

JPR-VP0050D



■ ENGINE MODEL
D5, D7

■ PUMP P/N
3838288

No	JMP	VOLVO PENTA	DESCRIPTION	QTY	REMARK
1	JPR-VP0050D	3838288	SEA WATER PUMP	1	
2	BER0045	181800	BALL BEARING	2	
3	BOL0080	808825	SCREW, COVER	6	
4	CAMSET000301		CAM SET	1	
5	COV0046	815573	END COVER	1	
6	GAK0062	808275	GASKET, COVER	1	
7	7400-01	21951356	IMPELLER	1	
8	KEY0028	N/A	KEY, GEAR	1	
9	MCSSET0001	822708	MECHANICAL SEAL SET	1	
10	ORG0044	826238	O-RING, SLINGER	1	
11	SHA0104	N/A	SHAFT	1	
12	SNP0006	914451	SNAP RING, MECH SEAL	1	
13	SNP0009	914523	SNAP RING, LARGE	1	
14	SPC0019	3583988	SPACER	1	
15	RET0038	3812515	OIL SEAL	1	
16	WER0001	826246	WEAR PLATE	1	
17	JSM0079	N/A	MINOR KIT	1	
18	JSK0099	N/A	MAJOR KIT	1	ALL INTERNAL PARTS

JPR-VP0060DA



■ ENGINE MODEL
D6

■ PUMP P/N
21380890

No	JMP	VOLVO PENTA	DESCRIPTION	QTY	REMARK
1	JPR-VP0060DA	21380890	SEA WATER PUMP	1	
2	BER0052	21422639	BALL BEARING	2	
3	BOL0081	3583604	SCREW, END COVER	6	
4	CAMSET0037	3583604	CAM SET	1	
5	7446-01	3593573	IMPELLER	1	
6	ORG0071	3583611	O-RING, END COVER	1	
7	MCSSET0023	3583609	MECHANICAL SEAL SET	1	
8	KEY0032	888386	KEY, WOODRUFF	1	
9	PBC0218	3583600	END COVER	1	
10	SHA0125	21560034	SHAFT	1	
11	SNP0004	804709	SNAP RING, PULLEY	1	
12	SNP0006	809444	SNAP RING, MECH SEAL	1	
13	SNP0013	21422641	SNAP RING (LARGE)	1	
14	SPC0019	888388	SHIM, MECH SEAL	1	
15	WER0029	807589	WEAR PLATE	1	
16	JSM0102	N/A	MINOR KIT	1	
17	JSK0102	N/A	MAJOR KIT	1	ALL INTERNAL PARTS

JPR-VP0060DB



■ ENGINE MODEL
D6

■ PUMP P/N
21419376

No	JMP	VOLVO PENTA	DESCRIPTION	QTY	REMARK
1	JPR-VP0060DB	21419376	SEA WATER PUMP	1	
2	BER0052	21422639	BALL BEARING	2	
3	BOL0163	21346724	SCREW, END COVER	6	
4	COV0051	N/A	END COVER	1	
5	7376-01	21422649	IMPELLER	1	
6	MCSSET0021	864649	MECHANICAL SEAL SET	1	
7	ORG0003	864648	O-RING, SLINGER	1	
8	ORG0032	3581618	O-RING, END COVER	1	
9	SHA0118	21422635	SHAFT	1	
10	SNP0008	943468	SNAP RING, MECH SEAL	1	
11	SNP0013	21422641	SNAP RING (LARGE)	1	
12	WER0028		WEAR PLATE	1	
13	JSM0084	N/A	MINOR KIT	1	
14	JSK0103	N/A	MAJOR KIT	1	ALL INTERNAL PARTS

JPR-VP0090D



■ ENGINE MODEL
D9

■ PUMP P/N
21380886

No	JMP	VOLVO PENTA	DESCRIPTION	QTY	REMARK
1	JPR-VP0090D	21380886	SEA WATER PUMP	1	
2	BER0059	3587881	BALL BEARING	1	
3	BOL0080	3583605	SCREW, END COVER	4	
4	CAMSET0036	3583603	CAM SET	1	
5	COV0047	3587879	END COVER	1	
6	7446-01	3819486	IMPELLER	1	
7	MCSSET0023	3583609	MECHANICAL SEAL SET	1	
8	ORG0059	925259	O-RING, MOUNTING (INNER)	1	
9	ORG0067	3587885	O-RING, END COVER	1	
10	ORG0070	949735	O-RING, MOUNTING (OUTER)	1	
11	RET0051	3587882	OIL SEAL	1	
12	SHA0120	21380884	SHAFT	1	
13	SNP0005	812951	SNAP RING (SMALL)	1	
14	SNP0006	809444	SNAP RING (MECHANICAL SEAL)	1	
15	SNP0014	812953	SNAP RING (LARGE)	1	
16	SPC0019	888388	SHIM, MECHANICAL SEAL	1	
17	WER0029	807589	WEAR PLATE	1	
18	GEA0021	3161258	GEAR	1	
19	JSM0077	N/A	MINOR KIT	1	
20	JSK0104	N/A	MAJOR KIT	1	ALL INTERNAL PARTS

JPR-VP0110DA



■ ENGINE MODEL
D11

■ PUMP P/N
21219723

No	JMP	VOLVO PENTA	DESCRIPTION	QTY	REMARK
1	JPR-VP0110DA	21219723	SEA WATER PUMP	1	
2	BER0059	3587881	BALL BEARING	1	
3	BOL0081	3583604	SCREW, END COVER	4	
4	CAMSET0038	21277458	CAM SET	1	
5	COV0037	N/A	END COVER	1	
6	8000-01	21730344	IMPELLER	1	
7	MCSSET0003	3829315	MECHANICAL SEAL SET	1	
8	ORG0059	3587885	O-RING, MOUNTING (INNER)	2	
9	ORG0070	925259	O-RING, MOUNTING (OUTER)	1	
10	SHA0122	N/A	SHAFT	1	
11	SNP0005	812951	SNAP RING (SMALL)	1	
12	SNP0014	812953	SNAP RING (LARGE)	1	
13	SPC0012	888388	SHIM, MECHANICAL SEAL	1	
14	WER0018	826230	WEAR PLATE	1	
15	GEA0021	3161258	GEAR	1	
16	JSM0085	N/A	MINOR KIT	1	
17	JSK0105	N/A	MAJOR KIT	1	ALL INTERNAL PARTS

JPR-VP0110DB



■ ENGINE MODEL
D11

■ PUMP P/N
22063494

No	JMP	VOLVO PENTA	DESCRIPTION	QTY	REMARK
1	JPR-VP0110DB	22063494	SEA WATER PUMP	1	
2	BER0059	3587881	BALL BEARING	1	
3	BOL0080	3583605	SCREW, END COVER	4	
4	CAMSET0037	3589908	CAM SET	1	WITH SCREW, PACKING
5	COV0047	3587879	END COVER	1	
6	7446-01	21730348	IMPELLER	1	
7	MCSSET0023	3583609	MECHANICAL SEAL SET	1	
8	ORG0059	925259	O-RING, MOUNTING (INNER)	1	
9	ORG0067	3587885	O-RING, END COVER	1	
10	ORG0070	949735	O-RING, MOUNTING (OUTER)	1	
11	RET0051	3587882	OIL SEAL	1	
12	SHA0120	21380884	SHAFT	1	
13	SNP0005	812951	SNAP RING (SMALL)	1	
14	SNP0006	809444	SNAP RING (MECHANICAL SEAL)	1	
15	SNP0014	812953	SNAP RING (LARGE)	1	
16	SPC0019	888388	SHIM, MECHANICAL SEAL	1	
17	WER0029	807589	WEAR PLATE	1	
18	GEA0021	3161258	GEAR	1	
19	JSM0086	N/A	MINOR KIT	1	
20	JSK0106	N/A	MAJOR KIT	1	ALL INTERNAL PARTS

JPR-VP0120D



■ ENGINE MODEL
D12

■ PUMP P/N
3838207

No	JMP	VOLVO PENTA	DESCRIPTION	QTY	REMARK
1	JPR-VP0120D	3838207	SEA WATER PUMP	1	
2	BER0005	11013	BALL BEARING	2	
3	BOL0081	963554	SCREW, END COVER	5	
4	CAMSET0028	3830661	CAM SET	1	WITH SCREW, PACKING
5	COV0037	3817938	END COVER	1	
6	8326-01	3830459	IMPELLER	1	
7	MCSSET0003	3829315	MECHANICAL SEAL SET	1	
8	NIP0014	981749	DRAIN PLUG	1	
9	ORG0059	925259	O-RING, END COVER	1	
10	ORG0063	949736	O-RING, MOUNTING (VITON)	1	
11	RET001301	845795	OIL SEAL	1	
12	SHA0114	3838208	SHAFT	1	
13	SNP0013	825735	SNAP RING	1	
14	WER0018	8262303	WEAR PLATE	1	
15	JSM0076	N/A	MINOR KIT	1	
16	JSK0095	N/A	MAJOR KIT	1	ALL INTERNAL PARTS

JPR-VP0130D



■ ENGINE MODEL
D13

■ PUMP P/N
3886848

No	JMP	VOLVO PENTA	DESCRIPTION	QTY	REMARK
1	JPR-VP0130D	3886848	SEA WATER PUMP	1	
2	BER0005	11013	BALL BEARING	2	
3	BOL0081	3583605	SCREW, END COVER	5	
4	BOL0160	3587886	HEX NUT	1	
5	BOL0161	941914	SPRING WASHER	1	
6	CAMSET0028	3830661	CAM SET	1	WITH SCREW, PACKING
7	COV0037	3817938	END COVER	1	
8	8326-01	3830459	IMPELLER	1	
9	MCSSET0003	3829315	MECHANICAL SEAL SET	1	
10	ORG0059	925259	O-RING	1	
11	ORG0060	992065	O-RING, MOUNTING (VITON)	1	
12	RET001301	845795	OIL SEAL	1	
13	SHA0113	21165584	SHAFT	1	
14	SNP0013	825735	SNAP RING	1	
15	WER0018	826230	WEAR PLATE	1	
16	GEA0020	8131848	GEAR	1	
17	JSM0076	N/A	MINOR KIT	1	
18	JSK0096	N/A	MAJOR KIT	1	ALL INTERNAL PARTS

JPR-VP0160D



■ ENGINE MODEL
D16

■ PUMP P/N
3589104

No	JMP	VOLVO PENTA	DESCRIPTION	QTY	REMARK
1	JPR-VP0160D	3589104	SEA WATER PUMP	1	
2	BER0005	11013	BALL BEARING	2	
3	BOL0081	3583605	SCREW, END COVER	5	
4	CAMSET0028	3830661	CAM SET	1	WITH SCREW, PACKING
5	COV0037	3817938	END COVER	1	
6	8326-01	3830459	IMPELLER	1	
7	MCSSET0003	3829315	MECHANICAL SEAL SET	1	
8	ORG0059	925259	O-RING	1	
9	ORG0060	992065	O-RING, MOUNTING (VITON)	1	
10	RET001301	845795	OIL SEAL	1	
11	SHA0106	N/A	SHAFT	1	
12	SNP0013	825735	SNAP RING	1	
13	WER0018	826230	WEAR PLATE	1	
14	GEA0020	8131848	GEAR	1	
15	JSM0076	N/A	MINOR KIT	1	
16	JSK0075	N/A	MAJOR KIT	1	ALL INTERNAL PARTS

YANMAR ENGINE

SEA(RAW) WATER PUMPS AND PARTS

JPR-YM08IH

MOUNTING BRACKET INCLUDED



■ **ENGINE MODEL**
2GMF, 3GMF, 2YM, 3YM

■ **PUMP P/N**
128397-42500

JPR-YM08IH2

MOUNTING BRACKET INCLUDED

■ **ENGINE MODEL** 2GM, 3GM

■ **PUMP P/N** 128377-42500

No	JMP	YANMAR	DESCRIPTION	QTY	REMARK
1	JPR-YM08IH	128397-42500	SEA WATER PUMP	1	RE-ENGINEERED
1-1	JPR-YM08IH2	128377-42500	SEA WATER PUMP	1	RE-ENGINEERED
2	BER0054	X03431760	BALL BEARING	2	
3	BOL0144	128990-42520	SCREW, END COVER	6	
4	COV0042	X0142398000	END COVER	1	
5	7050-01	128397-42200	IMPELLER	1	
6	MCSSET0020	X02233010	MECHANICAL SEAL SET	1	
7	ORG0052	X02173476	O-RING, END COVER	1	
8	PBC0168	128397-42510	BODY (CAM 4MM)	1	
8-1	PBC0168	128397-42510	BODY (CAM 2MM)	1	
9	PUL0027	124070-42400	V-PULLEY	1	MACHINED PULLEY
10	SHA0095	X0146541000	SHAFT	1	
11	SNP0026	X00370012	SNAP RING	1	
12	SNP0025	X00371732	SNAP RING	1	
13	JSM0091	N/A	MINOR KIT	1	
14	JSK0082	N/A	MAJOR KIT	1	ALL INTERNAL PARTS

JPR-YM04JHA



■ **ENGINE MODEL**
3JH3, 4JH3, 4JH4 SERIES

■ **PUMP P/N**
129670-42513

No	JMP	YANMAR	DESCRIPTION	QTY	REMARK
1	JPR-YM04JHA	129670-42513	SEA WATER PUMP	1	
2	BER0050	X0508129	BEARING	2	
3	BOL0163	129271-42510	HEX SCREW, END COVER	4	
4	COV0050	129670-42520	END COVER	1	
5	GEA0024	129670-42700	GEAR	1	
6	7100-01	129670-42531	IMPELLER	1	
7	KEY0028	129670-42580	KEY	1	
8	MCSSET0001	129670-42560	MECHANICAL SEAL SET	1	
9	ORG0061	119773-42570	O-RING, END COVER	1	
10	ORG0062	120650-42420	O-RING (V-RING / SLINGER)	1	
11	RET0013	X0529105	RETAINER	1	
12	SHA0134	X0146531	SHAFT	1	
13	SNP0002	120650-42380	SNAP RING	1	
14	SNP0006	129670-42570	SNAP RING	1	
15	SNP0009	120650-42350	SNAP RING	1	
16	WER0024	129670-42540	WEAR PLATE	1	
17	JSM0130	N/A	MINOR KIT	1	
18	JSK0130	N/A	MAJOR KIT	1	ALL INTERNAL PARTS

JPR-YM04JHB



■ **ENGINE MODEL**
3JH4, 3JH5, 4JH4, 4JH5 SERIES

■ **PUMP P/N**
129271-42502

No	JMP	YANMAR	DESCRIPTION	QTY	REMARK
1	JPR-YM04JHB	129271-42502	SEA WATER PUMP	1	
2	BER0050	X0508129	BEARING	2	
3	BOL0163	129271-42510	HEX SCREW, END COVER	4	
4	COV0050	129670-42520	COVER	1	
5	GEA0025	129670-42700	GEAR	1	
6	7100-01	129271-42700	IMPELLER	1	
7	KEY0028	129670-42580	KEY	1	
8	MCSSET0001	129670-42560	MECHANICAL SEAL SET	1	
9	NIP0033	123325-49421	HOSE, PIPE	1	
10	ORG0061	119773-42570	O-RING (COVER)	1	
11	ORG0062	120650-42420	O-RING (V-RING / SLINGER)	1	
13	RET0013	X0529105	RETAINER	1	
14	SHA0134	X0146531	SHAFT	1	
15	SNP0002	120650-42380	SNAP RING	1	
16	SNP0006	129670-42570	SNAP RING	1	
17	SNP0009	120650-42350	SNAP RING	1	
18	WER0024	129670-42540	WEAR PLATE	1	
19	JSM0130	N/A	MINOR KIT	1	
20	JSK0130	N/A	MAJOR KIT	1	ALL INTERNAL PARTS

JPR-YM06LPA



- ENGINE MODEL 6LP(A) SERIES
- PUMP P/N 119773-42502

JPR-YM06LPB



- ENGINE MODEL 6LP(A) SERIES
- PUMP P/N 119773-42652

JPR-YM06LY2



- ENGINE MODEL 6LY2 SERIES
- PUMP P/N 119574-42502

JPR-YM06LY3



- ENGINE MODEL 6LY3 SERIES
- PUMP P/N 119578-42501

No	JMP	YANMAR	DESCRIPTION	QTY	REMARK
1	JPR-YM06LPA	119773-42502	SEA WATER PUMP	1	
1-1	JPR-YM06LPB	119773-42652	SEA WATER PUMP	1	
2	BER0031	X0508511	BEARING	2	
3	BOL0163	119175-42620(COVER)	HEX SCREW, END COVER	4	
4	CAMSET0042	X0146502000	CAM SET	1	WITH SCREW, PACKING
5	COV0050	129670-42520	END COVER	1	
6	GEA0029	119773-42520	GEAR	1	
7	7136-01	119773-42600	IMPELLER	1	
8	KEY0013	22522-050160	WOODRUFF KEY, GEAR	1	
9	ORG0006	24321-000650	O-RING (MOUNTING)	1	
10	ORG0044	X0506501	O-RING (SLINGER)	1	
11	ORG0061	119773-42570	O-RING (END COVER)	1	
12	RET0013	X0529105	RETAINER	2	
13	SHA0133	X0146268000	SHAFT	1	
14	SNP0003	X0534107000	SNAP RING	1	
15	SNP0017	X0534507000	SNAP RING	1	
16	SPC0032	X0145181000	SPACER WASHER	1	
17	JSM0129	N/A	MINOR KIT	1	
18	JSK0129	N/A	MAJOR KIT	1	ALL INTERNAL PARTS

No	JMP	YANMAR	DESCRIPTION	QTY	REMARK
1	JPR-Y06LY2	119574-42502	SEA WATER PUMP	1	
2	BER0004	119578-42660	BEARING	2	
3	BOL0163	119175-42620	HEX SCREW	6	
4	CAMSET0041	119578-42610	CAM SET	1	WITH SCREW, PACKING
5	COV0055	119574-42560	END COVER	1	
6	7376-01	119574-42550	IMPELLER	1	
7	MCSSET0021	119578-42600	MECHANICAL SEAL SET	1	
8	ORG0014	24341-000800	O-RING (MOUNTING)	1	
9	ORG0074	119578-42640	O-RING (SLINGER)	1	
10	ORG0075	119574-42570	O-RING (END COVER)	1	
11	RET0053	119578-42650	RETAINER	1	
12	SHA0130	X0135771	SHAFT	1	
13	SNP0008	119578-42670	SNAP RING	1	
14	SNP0011	119578-42680	SNAP RING	1	
15	WER0001	119578-42620	WEAR PLATE	1	
16	JSM0128	N/A	MINOR KIT	1	
17	JSK0128	N/A	MAJOR KIT	1	ALL INTERNAL PARTS

No	JMP	YANMAR	DESCRIPTION	QTY	REMARK
1	JPR-YM06LY3	119578-42501	SEA WATER PUMP	1	
2	BER0004	119578-42660	BALL BEARING	2	
3	BOL0081	119578-42590	HEX SCREW, HOSE FLANGE	4	
4	BOL0182	119578-42570	HEX SCREW, END COVER	6	
5	CAMSET0041	119578-42610	CAM SET	1	WITH SCREW, PACKING
6	7376-01	119578-42550	IMPELLER	1	
7	MCSSET0021	119578-42600	MECHANICAL SEAL SET	1	
8	ORG0013	119578-42580	O-RING (JOINT, HOSE)	1	
9	ORG0074	119578-42640	O-RING (SLINGER)	1	
10	ORG0085	119578-42560	O-RING (ELBOW)	2	
11	PBC0226	119578-42540	END COVER HOUSING	1	
12	PBC0227	119578-42530	JOINT HOSE	1	
13	RET0053	119578-42650	RETAINER	1	
14	SHA0129	N/A	SHAFT	1	
15	SNP0008	119578-42670	SNAP RING	1	
16	SNP0011	119578-42680	SNAP RING	1	
17	WER0001	119578-42620	WEAR PLATE	1	
18	JSM0127	N/A	MINOR KIT	1	
19	JSK0127	N/A	MAJOR KIT	1	ALL INTERNAL PARTS

PERFORMANCE TABLE

Performance tables show approximate flow liter per minute for a new pump with a synthetic impeller and a full cam at 20°C. For Nitrile Impellers, reduce flow by 10% (Full Cam, Impeller Hardness 70)

JPR-25 series (with 7400 impellers)

rpm bar	500	1000	1800	2000
0	27	58	106	122
1	25	53	100	116
2	20	44	86	100
3	-	24	63	77
MAX	-	3.6 bar	4.4 bar	-

JPR-32 series (with 750X impellers)

rpm bar	500	1000	1800	2000
0	39	78	158	170
1	33	70	138	162
2	27	60	127	138
3	13	44	105	114
MAX	3.4 bar	4.4 bar	5 bar	-

JPR-40 series (with 800X, 810X impellers)

rpm bar	500	1000	1800	2000
0	66	138	268	295
1	57	122	250	283
2	44	103	232	250
3	21	77	175	203
MAX	3.4 bar	4.2 bar	-	-

JPR-50 series (with 820X, 830X impellers)

rpm bar	500	1000	1800	2000
0	105	213	394	448
1	89	186	351	406
2	65	146	310	333
3	-	77	220	241
MAX	-	3.6 bar	4.2 bar	-

JPR-L50 series (with 8400 impellers)

rpm bar	500	1000	1800	2000
0	125	236	448	500
1	86	176	382	420
2	-	27	220	241
3	-	-	-	-
MAX	-	-	-	-

JPR-L65 series (with 9100 impellers)

rpm bar	500	1000	1800	2000
0	175	325	591	651
1	155	277	566	591
2	115	228	482	542
3	33	116	351	394
MAX	3.2 bar	3.6 bar	4.2 bar	-

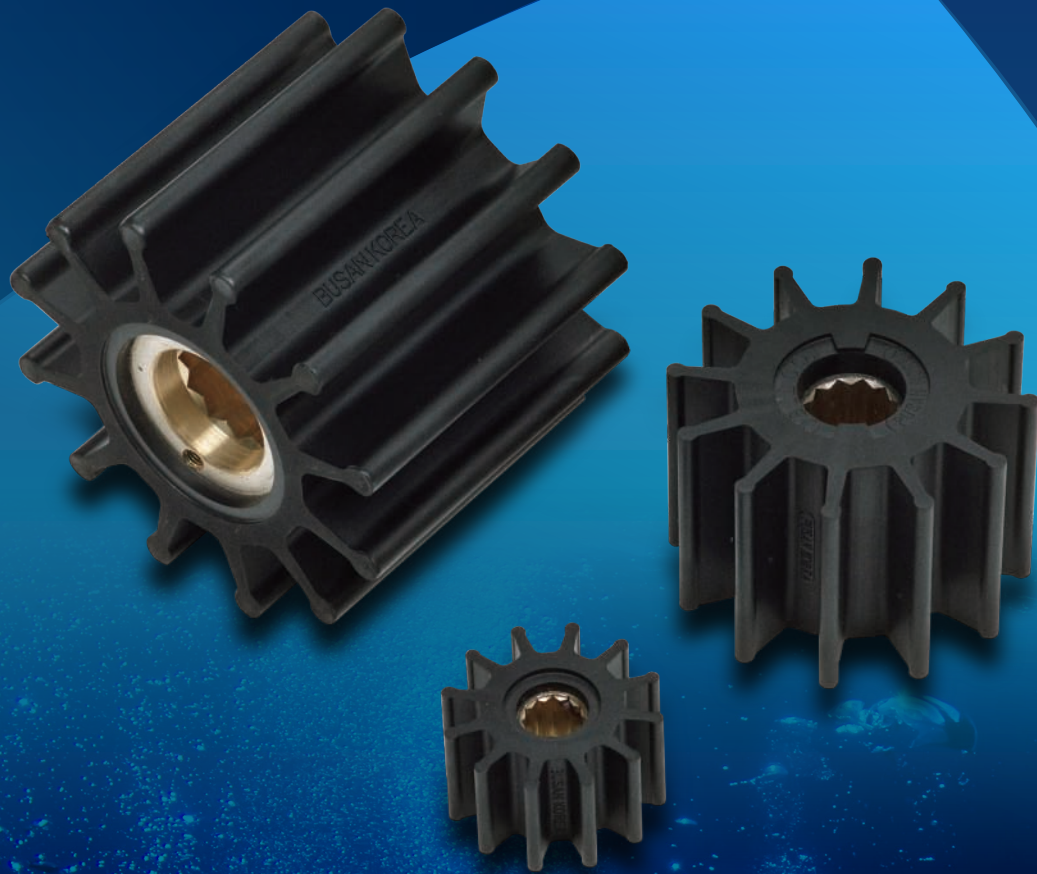

FLEXIBLE IMPELLERS

Quality you can depend on

FLEXIBLE IMPELLER IDENTIFICATION GUIDE

As you know, Flexible impellers are the most important part in Flexible impeller pumps. We improve the impeller performance by special surface coating, decreasing wear and tear so the impellers can last a long time.

We recommend you should change the impeller every year. We can guarantee that you will have great satisfaction with JMP flexible impellers.

(**▲ CAUTION:**We do not recommend using two screwdrivers as these will damage the surface of the pump body and O-ring sealing surface causing leaks. This practice can cause bodily injury in a confined space)

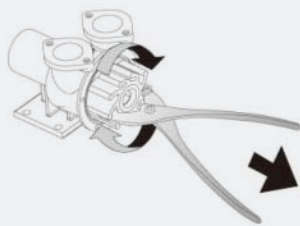

How to remove the old impeller

Using slip joint pliers, remove the impeller by twisting and then pulling in the rotating direction.

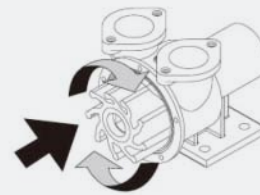

How to fit the new impeller

Lubricate the shaft, inside of the pump body and end cover. After arranging the new impeller with the shaft, mount the new one by pushing and twisting in rotating direction.

IDENTIFY THE IMPELLERS

The JMP Impeller has several trademarks printed outside of the impeller.

This guide is published on 1:1 scale so you can easily find the impeller (Serial, Size) you want.

IMPELLER REPLACEMENTS FOR

The following manufacturers or engine companies are available

CATERPILLAR, CUMMINS, DETROIT DIESEL, JABSCO, DOOSAN(DAEWOO), HYUNDAI, JOHN DEERE, JOHNSON PUMP, NORTHERN LIGHTS, KASHIYAMA, KOMATSU, MAN, MITSUBISHI, ONAN, PERKINS, SCANIA, SHERWOOD, VETUS, VOLVO PENTA, YANMAR and more.

IMPELLER SELECTION

Synthetic and Nitrile materials are available for most pumps. Synthetic impellers are the most common uses and suitable for small amount of bilge. Nitrile impellers offer better resistance for bilge. Please contact us if you want to use for other applications.

TEMPERATURE RANGE

Synthetic 41 °F ~ 140 °F (5°C~60°C)

Nitrile 50 °F ~ 180 °F (10°C~82°C)





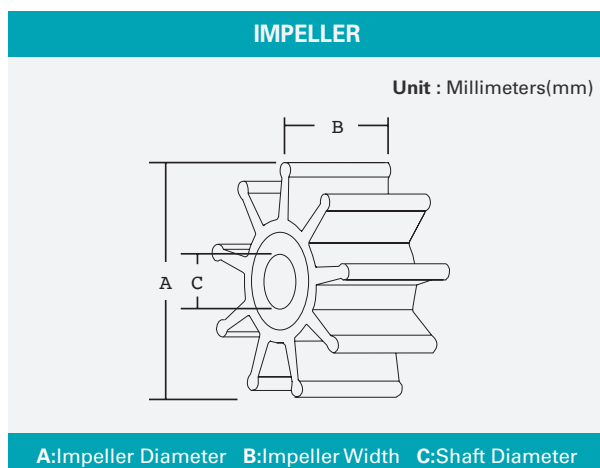



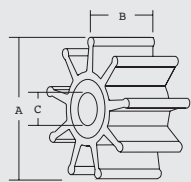

NOTICE

Do not run the pump dry for over 30 seconds



No	INSERT TYPE	
1	SLOTTED SHAFT PIN DRIVE	
2	KEY DRIVE	
3	SINGLE FLAT DRIVE	
4	DOUBLE FLAT DRIVE	
5	HEXA SPLINE DRIVE	
6	SPLINE DRIVE(12)	
7	SPLINE DRIVE(14)	
8	SPLINE DRIVE(11)	
9	SPLINE DRIVE(10)	

IMPELLER CROSS REFERENCE GUIDE

IMPELLER		No	INSERT TYPE
 <p>Unit : Millimeters(mm)</p> <p>A:Impeller Diameter B:Impeller Width C:Shaft Diameter</p>		1	SLOTTED SHAFT PIN DRIVE 
		2	KEY DRIVE 
		3	SINGLE FLAT DRIVE 
		4	DOUBLE FLAT DRIVE 
		5	HEXA SPLINE DRIVE 
		6	SPLINE DRIVE(12) 
		7	SPLINE DRIVE(14) 
		8	SPLINE DRIVE(11) 
		9	SPLINE DRIVE(10) 

JMP	DIMENSION			BLADES	INSERT TYPE	JABSCO	JOHNSON	NIKKISO	KASHIYAMA	SHERWOOD
	A	B	C							
6000	32	12	8	6	3	(2)1414-0001				
7000	39.7	19.2	12	6	1	22405-0001	09-808B			
7001	39.7	19.2	9.5	6	1	4528-0001	09-806B			9979
7013	39.7	19.2	12	6	3					8000
7050	51	22	12	6	1	653-0001	09-810B			
7051	51	22	12.7	6	1	673-0001	09-1026B			
7052	51	22	12.7	6	2	22799-0001				
7053	51	22	8	6	3	6303-0001	09-824P			
7054	51	22	12.7	6	3	Oberdorfer 6593				
7070	51	22	12	10	1	18653-0001				
7071	51	22	12.7	10	1	18673-0001				
7072	51	22	12.7	10	3					
7100	57	31.5	16	12	6	1210-0001	09-1027B	F15CBC	KP-30	
7110	57	20	12.7	12	2					10077
7136	57	48.2	16	12	6	13554-0001	09-812B			
7151	57.5	31.2	16	8	1			F15		
7162	62.5	22.2	16	12	2					
7172	62.5	22.4	16	12	2					9000
7192	62.5	32	16	12	2	18838-0001	09-701B			9959
7200	65	37	16	8	6	11979-0001				
7205	65	45	16	8	5			F20		
7300	65	41.5	15.8	12	2	18948-0001	09-702B			10615
7306	65	41.5	16	12	6				SP-60	
7352	65	51	15.8	12	2					15000
7356	65.3	50.4	16	12	6					
7376	65.8	80	25	12	6		09-821B			
7400	65	50	16	8	6	920-0001	09-1028B	F20CBC	SP-70	18200
7405	65	50	16	8	5					
7420	65	68	15.8	10	6	31130-0061			SP-130	
7426	65	50	15.8	10	6	17937-0001				
7436	65	50	15.8	10	6	YAMAHA 72X-12457-00				
7446	65	76	16	8	6	17018-0001				
7500	79	54	20	8	2			F25KBC		
7501	79	53.3	20	8	6					
7502	79	54	19	8	4					
7526	79	54	20	9	6				KP-100	
7556	80	75	20	9	6				SP-170	
7600	82.4	73.4	20	12	2	18958-0001	09-704B			17000
7608	82.4	73.4	20	12	8					27000
8000	95	63	25	9	6	836-0001	09-1029B	F40CBC	SP-200/220	
8001	95	63	25	9	4					
8002	95	63	25	9	5			F40	SPM-200	
8016	95	43	25	9	6				SP-150	
8100	95	63	25	12	6	17935-0001	09-819B			
8101	95	63	25	12	4					
8124	95	63	25.3	11	4					
8159	95	80	25	12	9					26000
8200	95	88.8	25	9	6	6760-0001	09-802B		SP-280	
8201	95	88.5	25	9	4					
8205	95	88.8	25	9	5					
8250	95	95	25	9	6				KP-300	
8300	95	88.8	25	12	4	17370-0001				
8301	95	88.8	25	12	6	17936-0001	09-814B			
8309	95.8	88.5	24	12	9					
8326	95	95	25	12	6	17938-0001				
8350	95	101.5	24	12	7		09-705B			18000
8359	95	101.5	24	12	9					29000
8400	100	100	25	9	6					
8406	100	100	25	10	6				SP-400	
8457	114.4	109.6	24	10	7					22000
8459	114.4	109.6	24	10	9					30000
8503	110	75.5	25	10	3			F50		
8506	110	75.5	25	10	6			F50S		
9000	117	88.5	25	9	4	18786-0001				
9001	117	88.5	25	9	6	18789-0001				
9100	128	101.5	36	12	6	31500-0001			SP-500	
9136	129	128	36	13	6				SP-600	
9202	128	101.5	38	6	2					
9206	128	101.5	36	6	6					
9212	128	101.5	34	6	2					
9500	132	31.5	25.4	18	2	15299-1000				

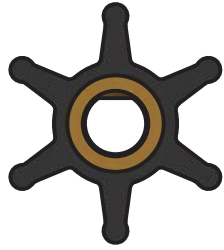

No	A	B	C	TYPE
6000	32	12	8	○

No	A	B	C	TYPE
7000	39.7	19.2	12	⊖
7001	39.7	19.2	9.5	⊖
7013	39.7	19.2	12	○

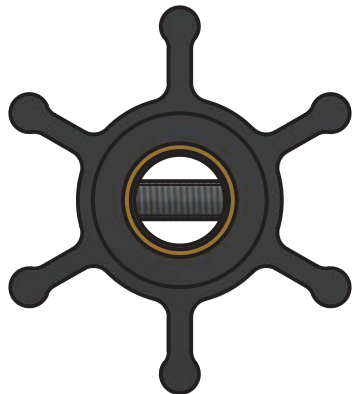
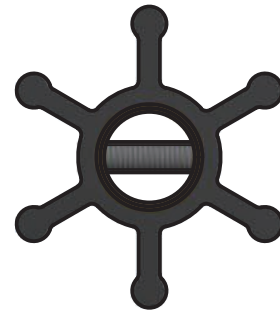

No	A	B	C	TYPE
7050	51	22	12	⊖
7051	51	22	12.7	⊖
7052	51	22	12.7	○
7053	51	22	8	○
7054	51	22	12.7	○

No	A	B	C	TYPE
7070	51	22	12	⊖
7071	51	22	12.7	⊖
7072	51	22	12.7	○

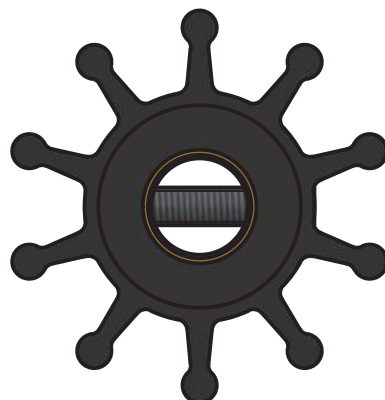



No	A	B	C	TYPE
7100	57	31.5	16	
7110	57	20	12.7	
7136	57	48.2	16	

No	A	B	C	TYPE
7151	57.5	31.2	16	

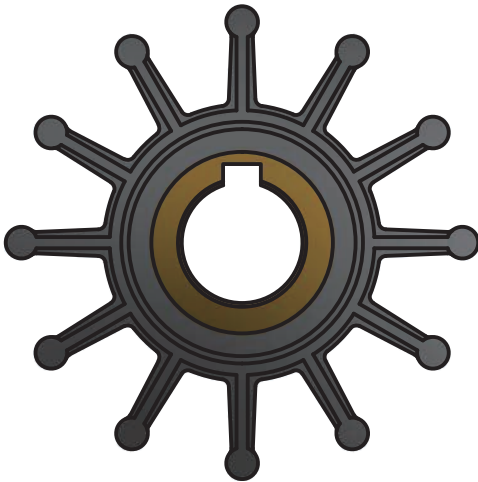
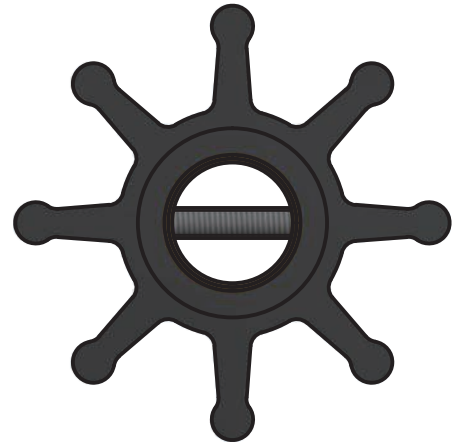





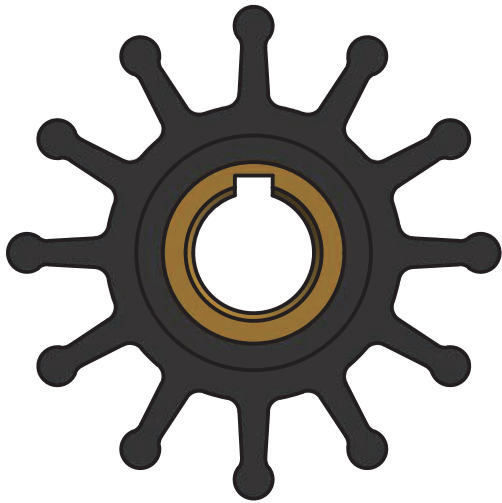

No	A	B	C	TYPE
7162	62.5	22.2	16	
7172	62.5	22.4	16	
7192	62.5	32	16	

No	A	B	C	TYPE
7200	65	37	16	
7205	65	45	16	
7400	65	50	16	
7405	65	50	16	
7446	65	76	16	







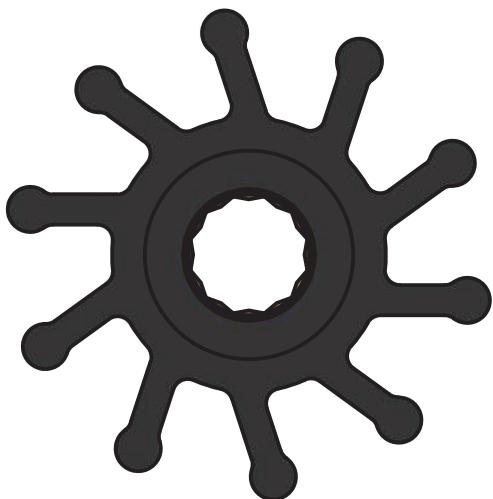
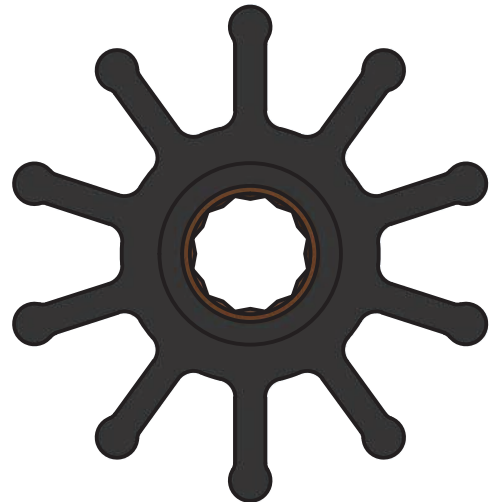

No	A	B	C	TYPE
7300	65	41.5	15.8	
7306	65	41.5	16	
7352	65	51	15.8	
7356	65.3	50.4	16	
7376	65.8	80	25	

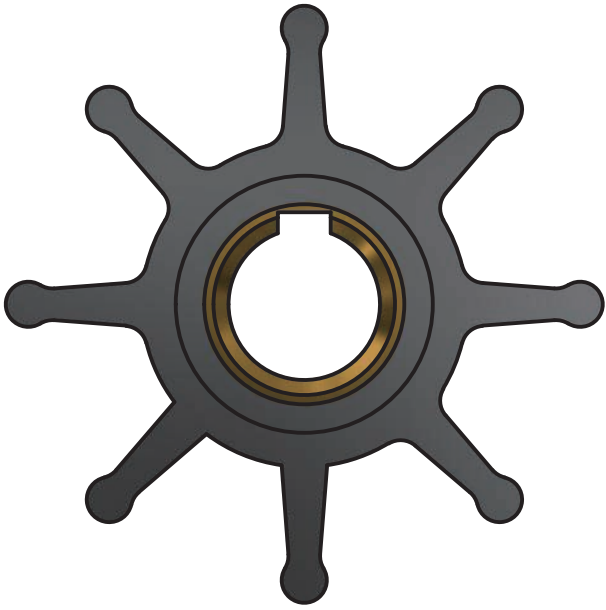

No	A	B	C	TYPE
7420	65	68	15.8	
7426	65	50	15.8	





No	A	B	C	TYPE
7436	65	50	15.8	

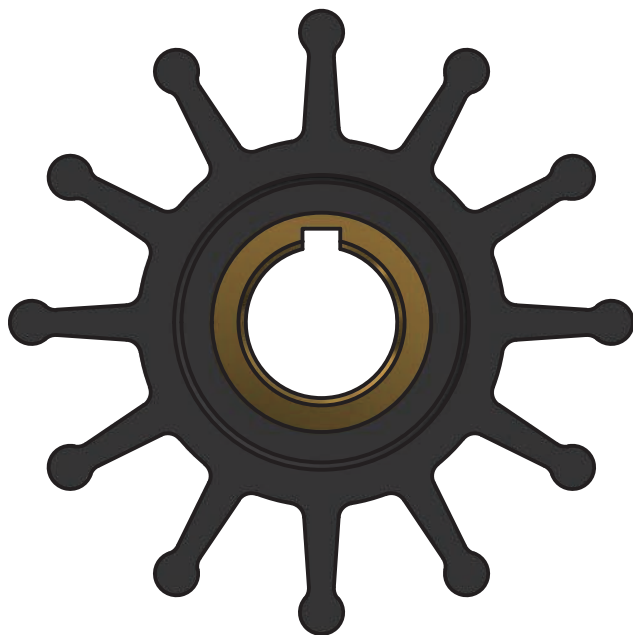

No	A	B	C	TYPE
7500	79	54	20	
7501	79	53.3	20	
7502	79	54	19	

No	A	B	C	TYPE
7526	79	54	20	
7556	80	75	20	



No	A	B	C	TYPE
7600	82.4	73.4	20	
7608	82.4	73.4	20	



No	A	B	C	TYPE
8000	95	63	25	
8001	95	63	25	
8002	95	63	25	
8016	95	43	25	
8200	95	88.8	25	
8201	95	88.5	25	
8205	95	88.8	25	
8250	95	95	25	

No	A	B	C	TYPE
8100	95	63	25	
8101	95	63	25	
8300	95	88.8	25	
8301	95	88.8	25	
8309	95.8	88.5	24	
8326	95	95	25	

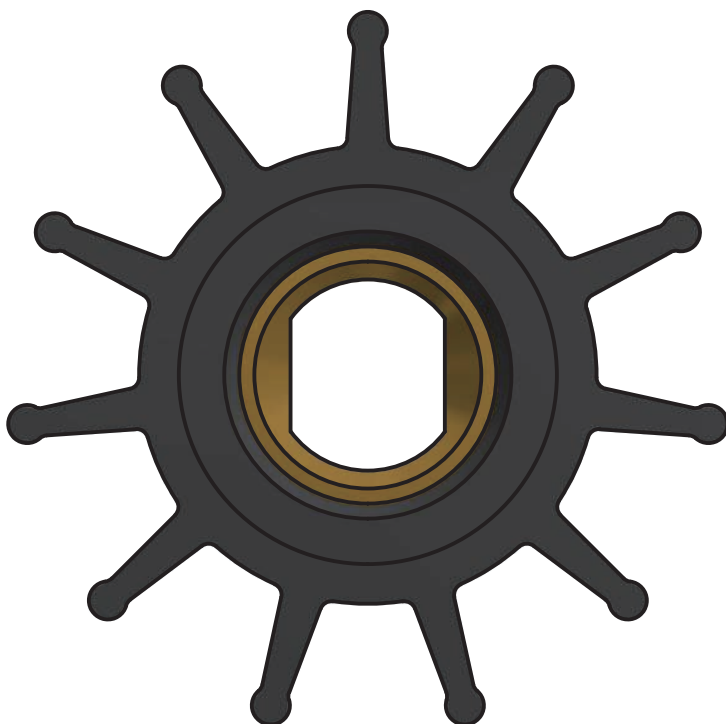
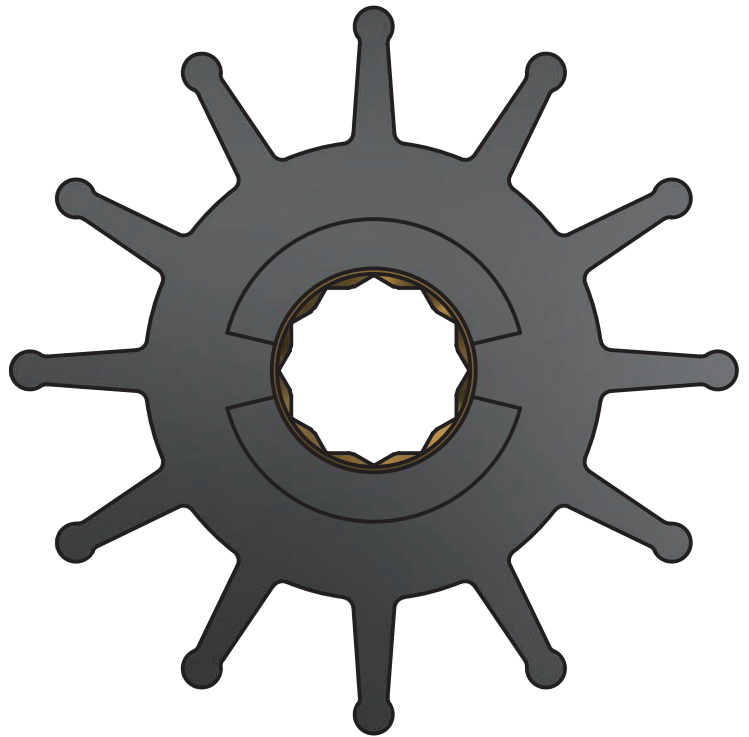

No	A	B	C	TYPE
8124	95	63	25.3	

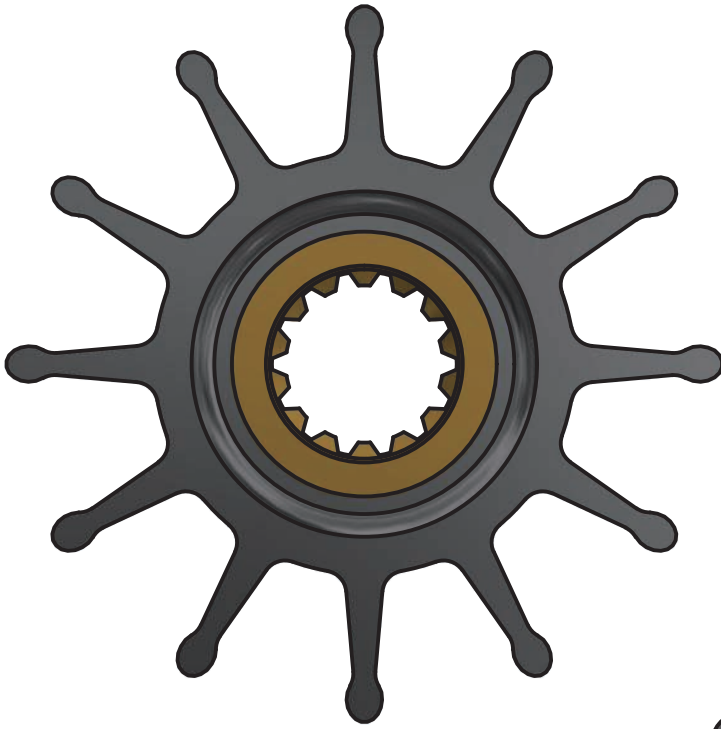

No	A	B	C	TYPE
8159	95	80	25	
8350	95	101.5	24	
8359	95	101.5	24	

No	A	B	C	TYPE
8400	100	100	25	

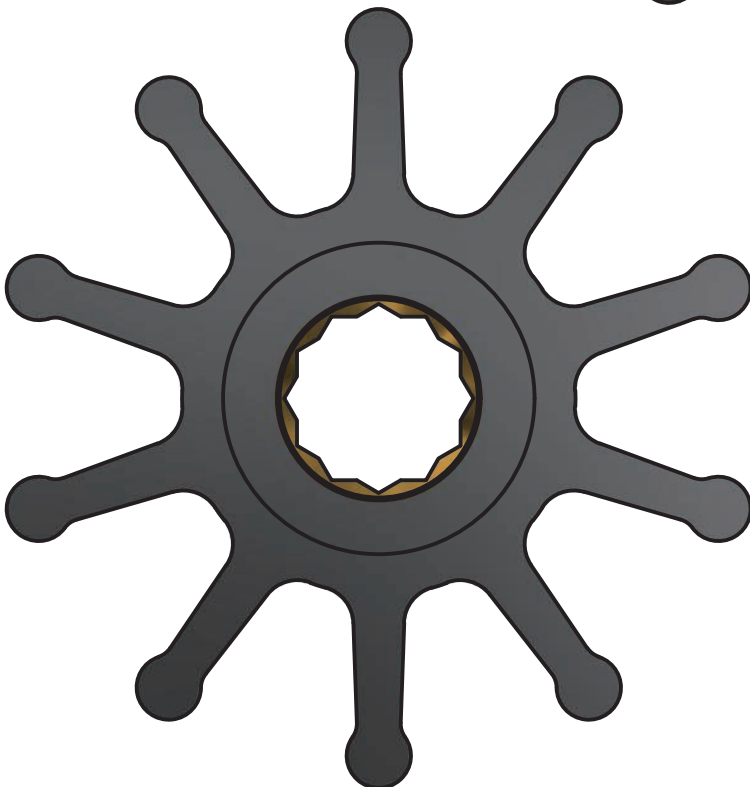
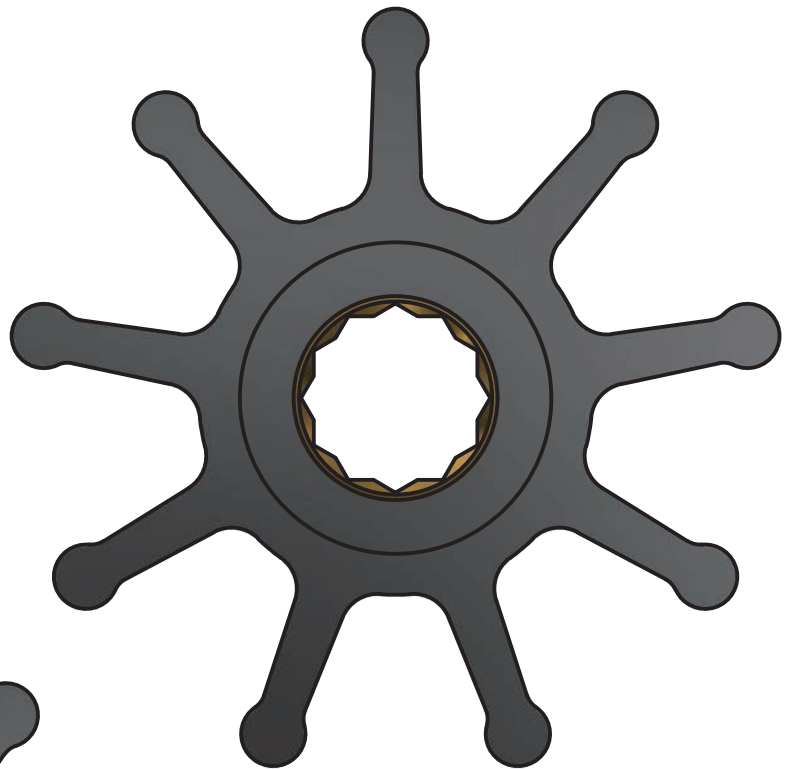

No	A	B	C	TYPE
8406	100	100	25	

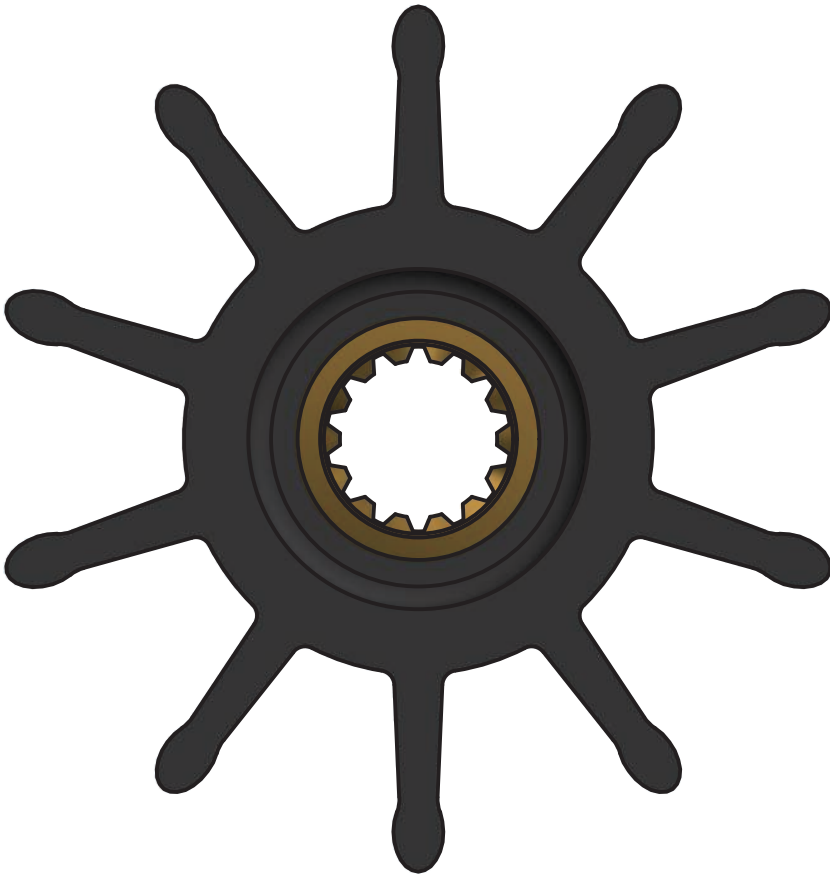

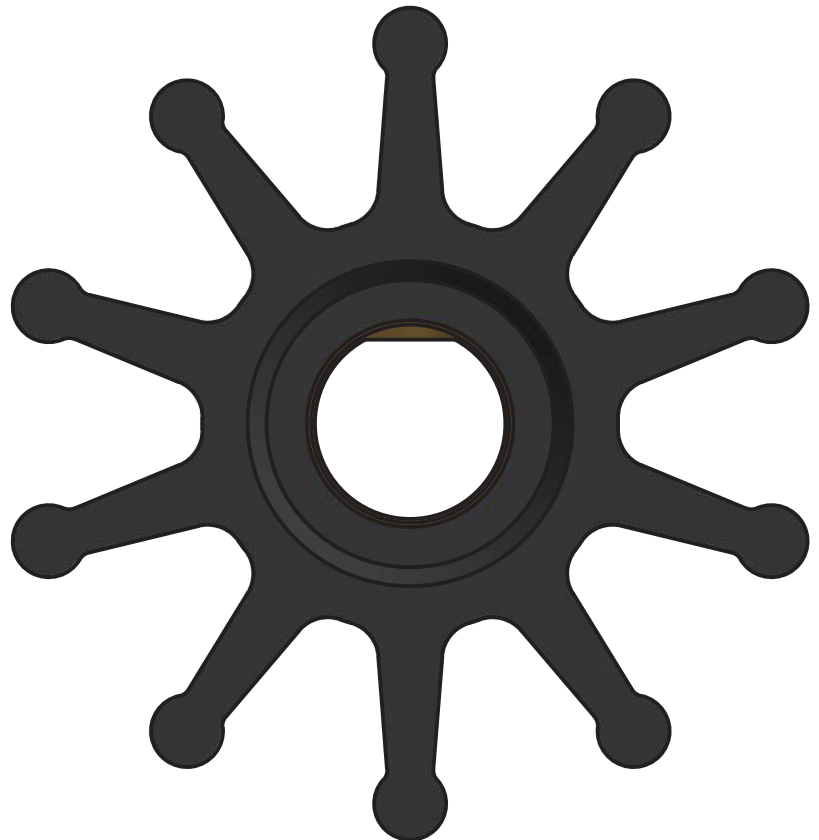

No	A	B	C	TYPE
8457	114.4	109.6	24	
8459	114.4	109.6	24	



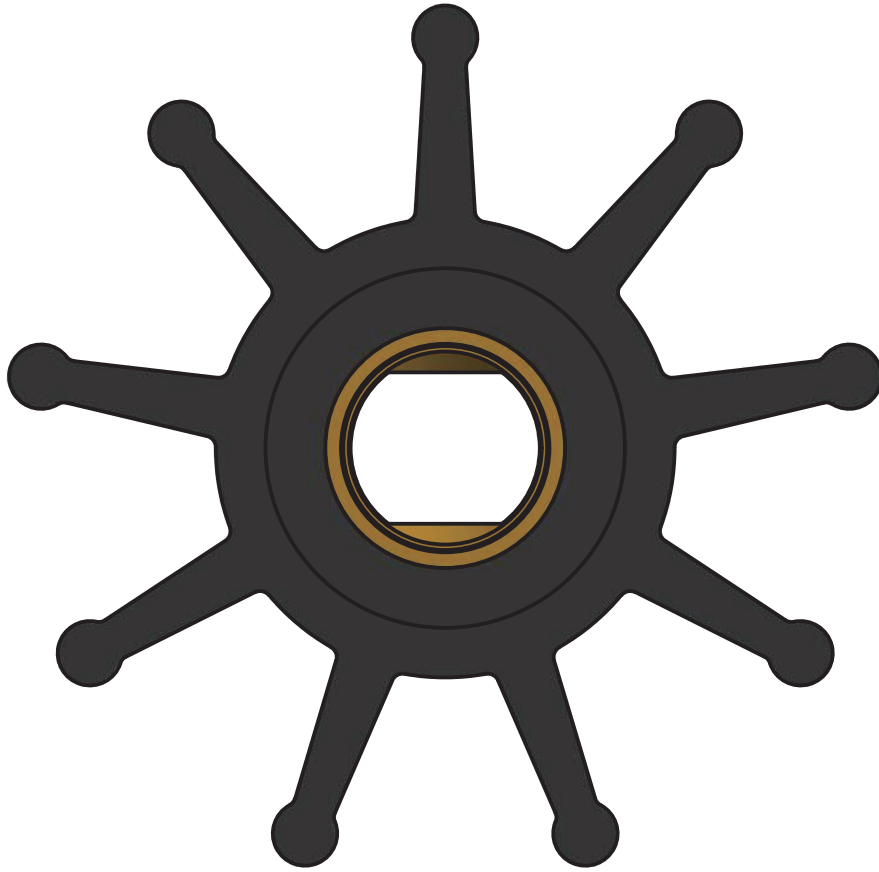

No	A	B	C	TYPE
8503	110	75.5	25	
8506	110	75.5	25	



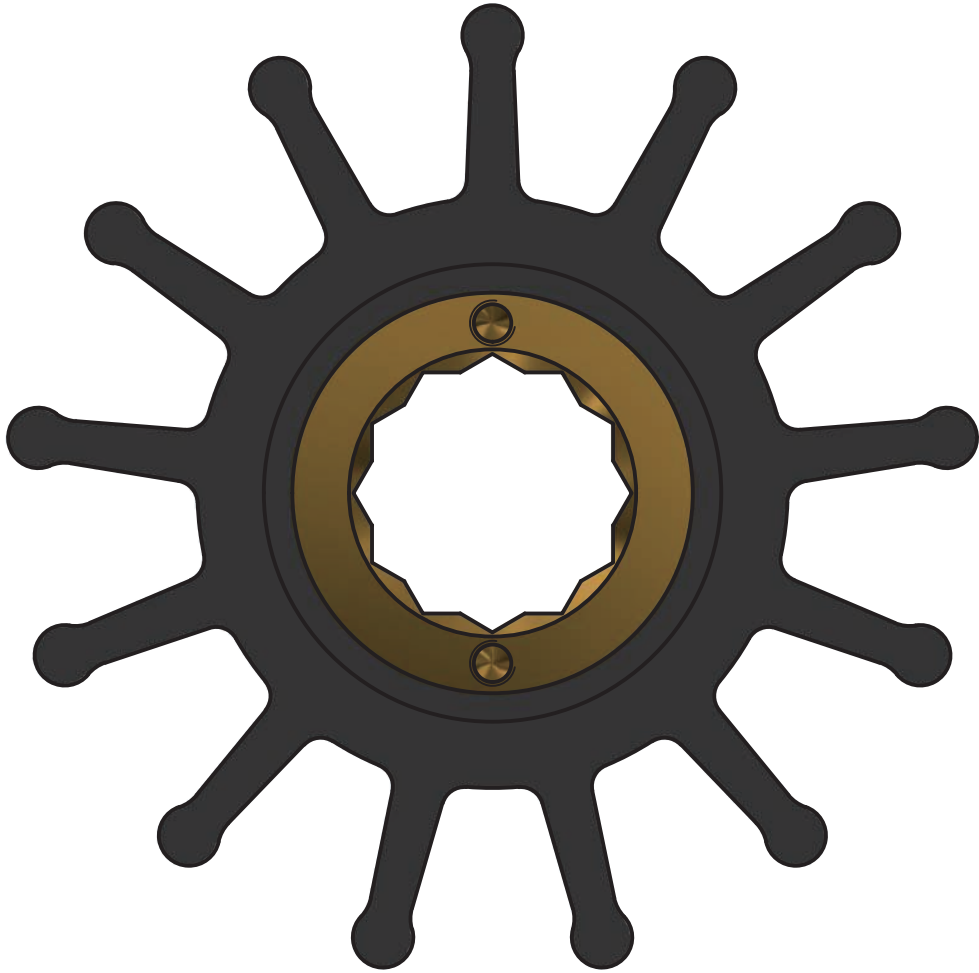

No	A	B	C	TYPE
9000	117	88.5	25	
9001	117	88.5	25	

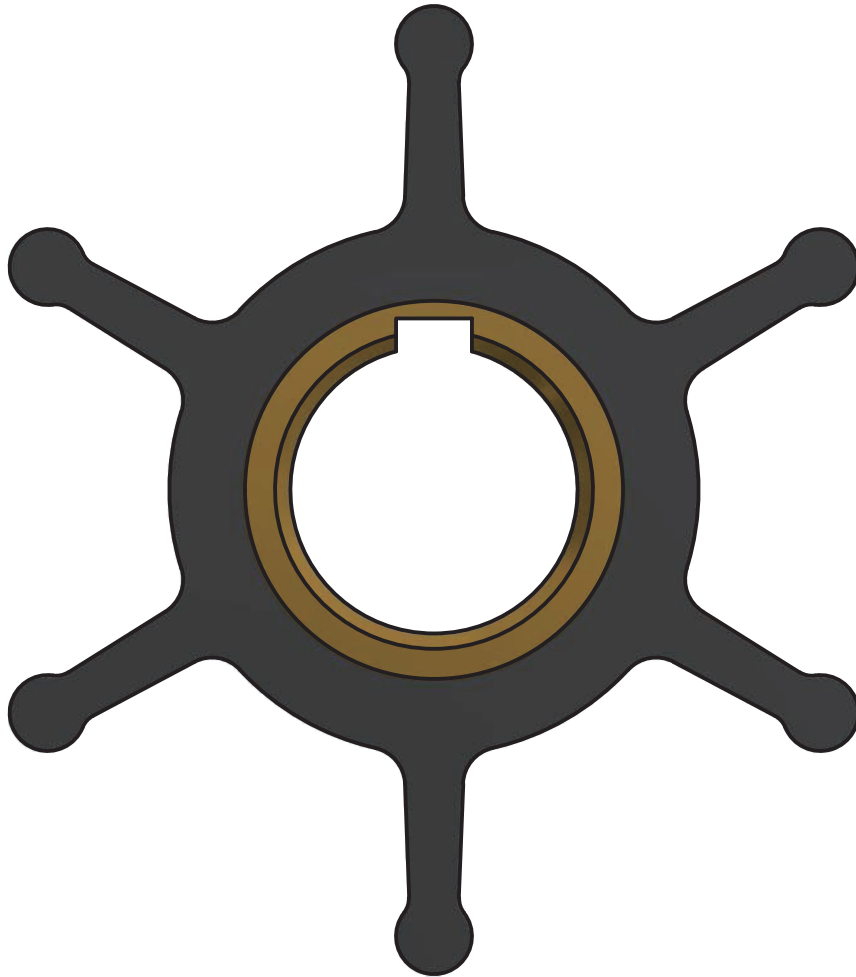

No	A	B	C	BLADES	TYPE
9100	128	101.5	36	12	
9136	129	128	36	13	



No	A	B	C	TYPE
9202	128	101.5	38	
9206	128	101.5	36	
9212	128	101.5	34	

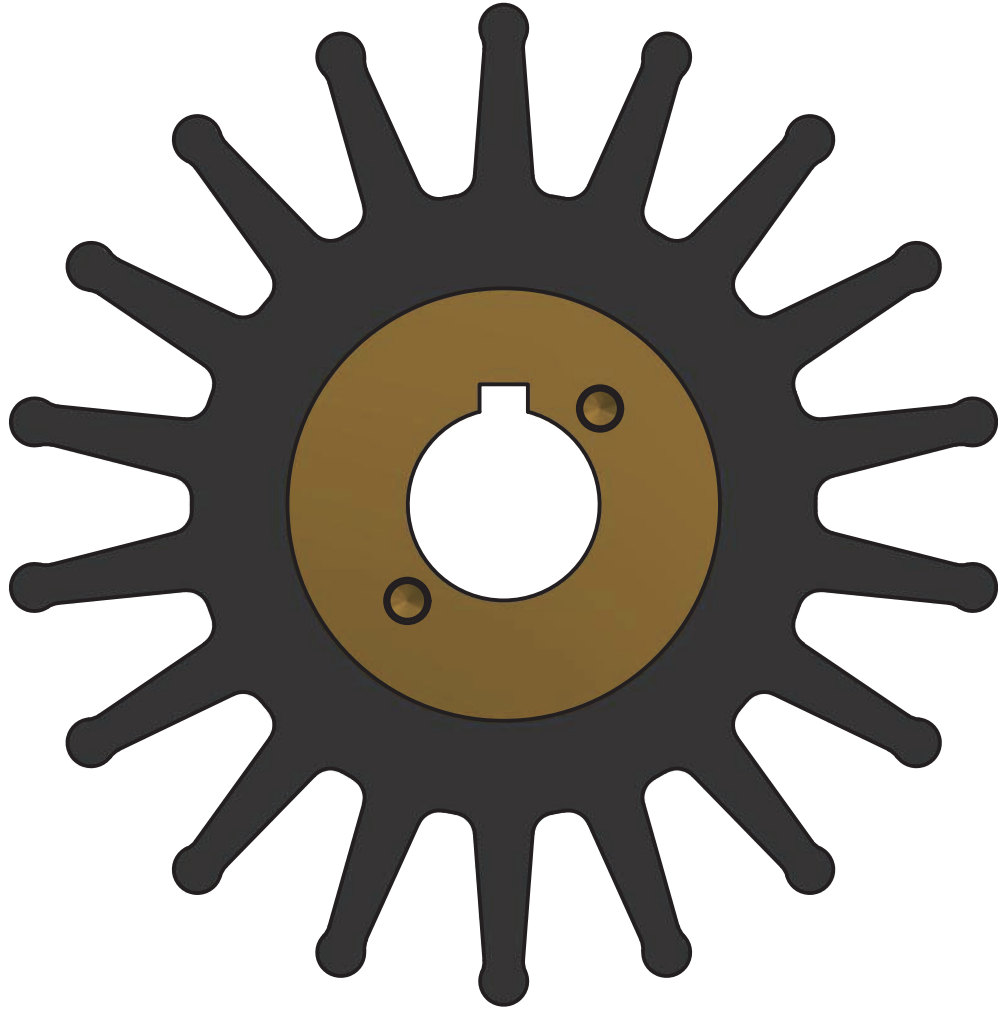

No	A	B	C	TYPE
9500	132	31.5	25.4	

JPR-ST SERIES

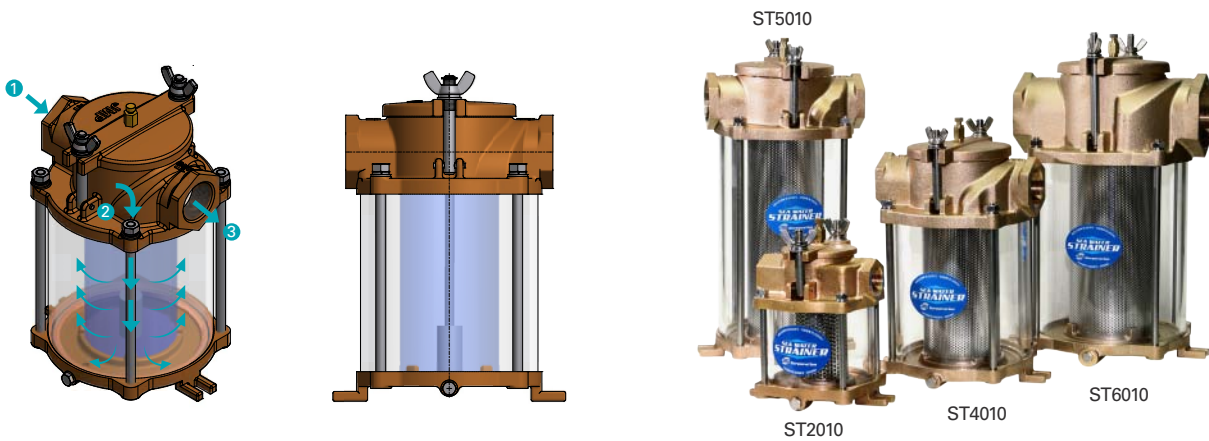

Features

- Robust Bronze Casting
- Robust Stainless with Chrome Plated Filter Baskets
- Easy Installation
- Easy Maintenance and Cleaning
- Protects Pumps and Engines
- Transparent and Strong Cylinder
- O-rings provide Better Sealing under High Pressure Applications

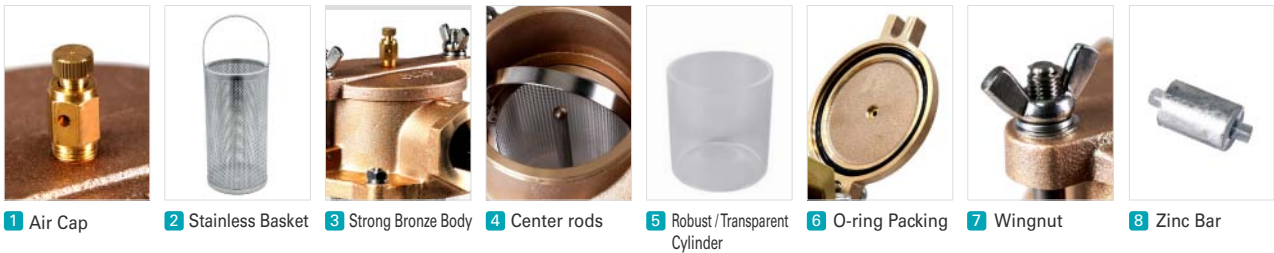

SPECIFICATION	JPR-ST2010	JPR-ST4010	JPR-ST5010	JPR-ST6010	JPR-ST7010
PORT SIZE	1" (PIPE)	1-1/2" (PIPE)	2" (PIPE)	2-1/2" (PIPE)	3" (PIPE)
TOP CASTING	BRONZE	BRONZE	BRONZE	BRONZE	BRONZE
BOTTOM CASTING	BRONZE	BRONZE	BRONZE	BRONZE	BRONZE
BASKET	STAINLESS	STAINLESS	STAINLESS	STAINLESS	STAINLESS
SEAL	O-RING	O-RING	O-RING	O-RING	O-RING
SIZE(A x B x C, mm)	150 x 220 x 180	210 x 334 x 235	210 x 435 x 235	260 x 445 x 275	260 x 445 x 275
CYLINDER (Dia x H, mm)	130 x 100	180 x 190	180 x 290	210 x 250	210 x 250
WEIGHT (Appx.)	5.7 kgs	10.0 kgs	11.5 kgs	17.8 kgs	16.4 kgs

How to Replace and Clean a Filter

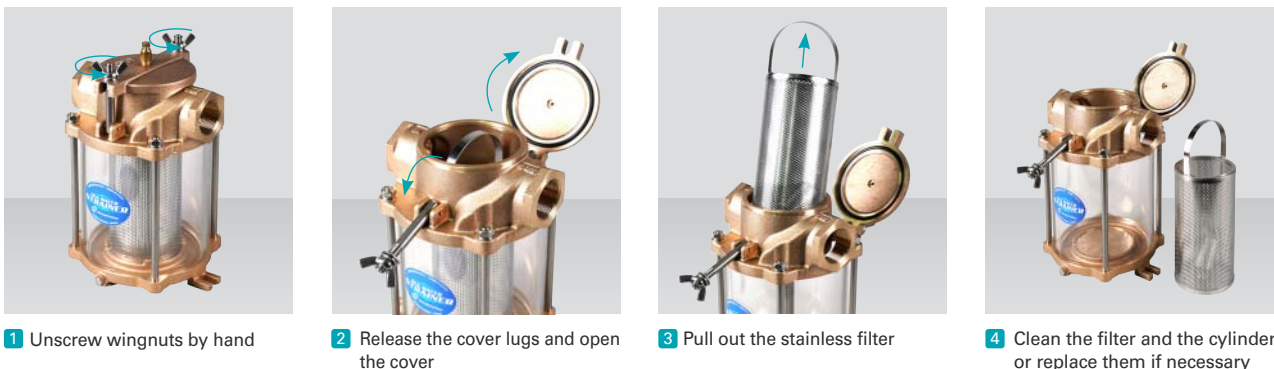

PARTS LIST FOR ST SERIES

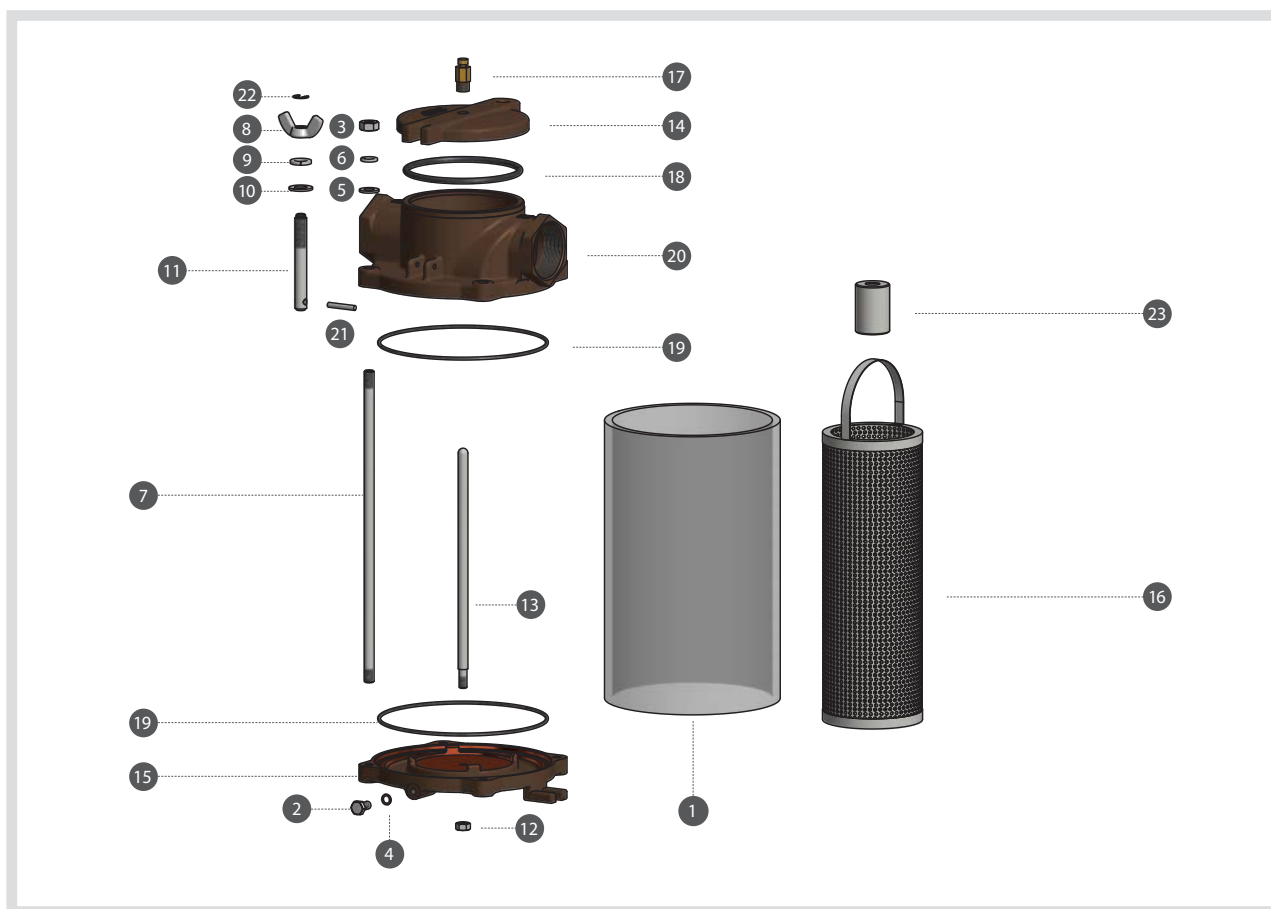

No	PART NAME	QTY	ST2010	ST4010	ST5010	ST6010	ST7010
1	CYLINDER	1	ACP0050	ACP0020	ACP0030	ACP0040	ACP0040
2	HEX BOLT	1	BOL0006	BOL0006	BOL0006	BOL0006	BOL0006
3	NUT	4	BOL0078	BOL0018	BOL0018	BOL0018	BOL0018
4	FLAT WASHER	1	BOL0031	BOL0031	BOL0031	BOL0031	BOL0031
5	FLAT WASHER	4	BOL0066	BOL0033	BOL0033	BOL0033	BOL0033
6	SPRING WASHER	4	BOL0036	BOL0038	BOL0038	BOL0038	BOL0038
7	STUD BOLT	4	BOL0122	BOL0061	BOL0062	BOL0085	BOL0085
8	WING NUT	2	BOL0063	BOL0063	BOL0063	BOL0063	BOL0063
9	SPRING WASHER	2	BOL0064	BOL0064	BOL0064	BOL0064	BOL0064
10	FLAT WASHER	2	BOL0065	BOL0065	BOL0065	BOL0065	BOL0065
11	GUIDE BOLT	2	BOL0124	BLO0077	BLO0077	BLO0086	BLO0086
12	NUT	1	BOL007801	BOL007801	BOL007801	BOL007801	BOL007801
13	CENTER BAR	1	BOL0123	BOL0098	BOL0098	BOL0098	BOL0098
14	COVER	1	PBC0113	PBC0159	PBC0159	PBC0162	PBC0162
15	BODY, BOTTOM	1	PBC0112	PBC0160	PBC0160	PBC0163	PBC0163
16	BASKET FILTER	1	FIL0008(3mm)	FIL000302(2mm)	FIL000402(2mm)	FIL000502(2mm)	FIL000502(2mm)
17	AIR VALVE	1	NIP0007	NIP0007	NIP0007	NIP0007	NIP0007
18	O-RING, COVER	1	ORG0007	ORG0005	ORG0005	ORG0019	ORG0019
19	O-RING, CYLINDER	2	ORG0018	ORG0023	ORG0023	ORG0020	ORG0020
20	BODY, HEAD	1	PBC0114	PBC0027	PBC0028	PBC0090	PBC0088
21	PIN	2	PIN0004	PIN0004	PIN0004	PIN0004	PIN0004
22	STOP RING	2	SNP0020	SNP0020	SNP0020	SNP0020	SNP0020
23	ANODE	1	ZEN000101	ZEN000101	ZEN000101	ZEN000101	ZEN000101

MEMO

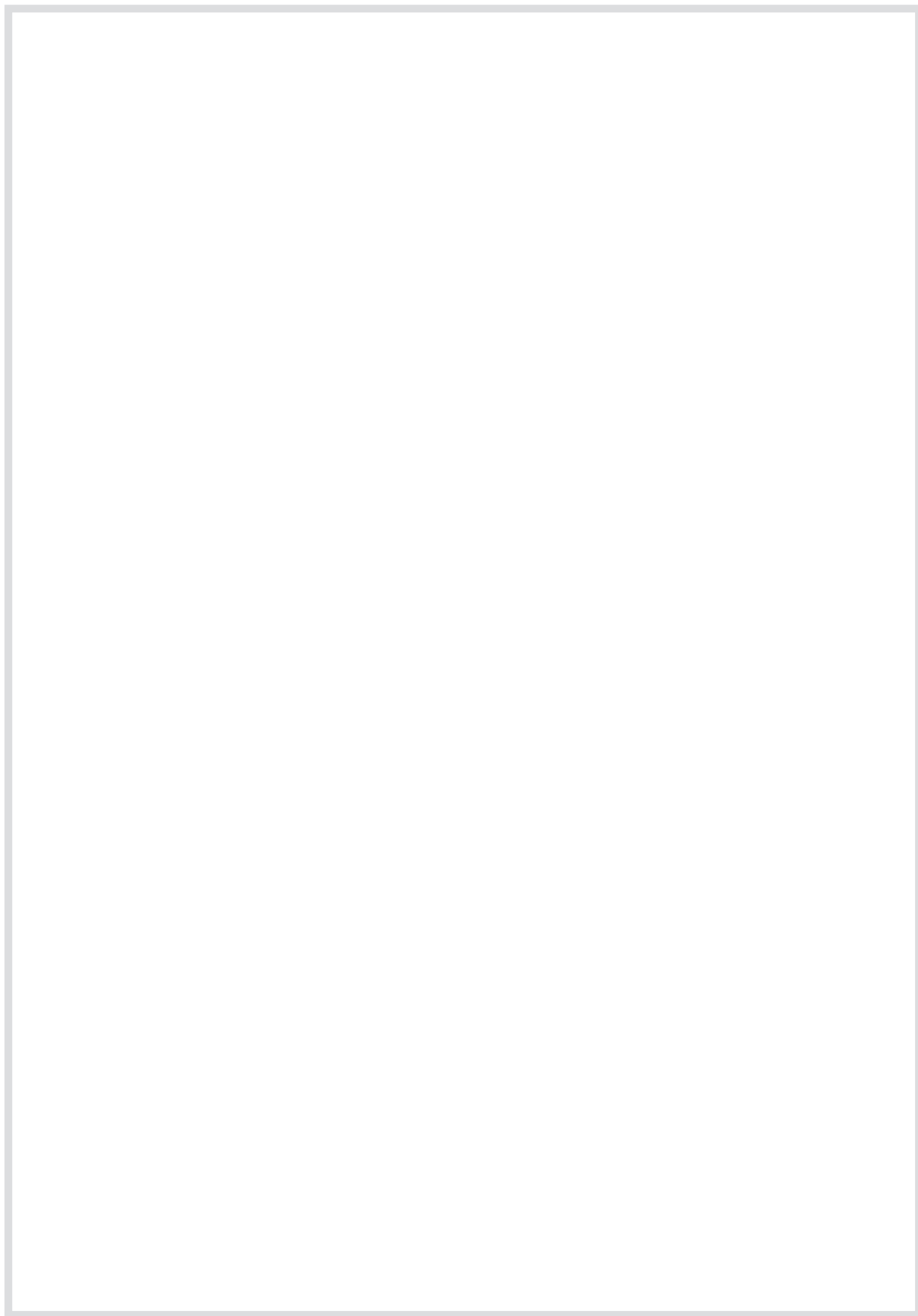

WORLDWIDE NETWORKS

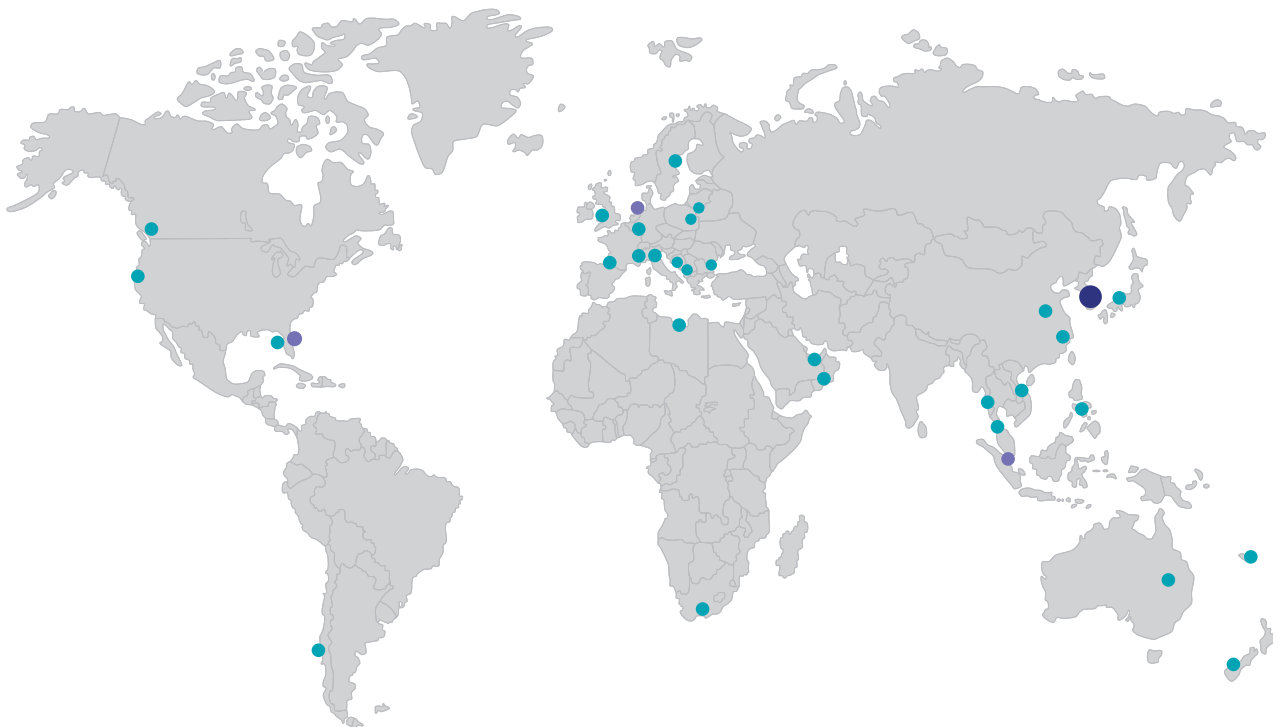

- **HEAD OFFICE & MAIN PRODUCTION PLANT**
- **WAREHOUSE (NETHERLANDS, SINGAPORE, USA)**
- **DISTRIBUTORS**

OVERSEAS DISTRIBUTORS

AMERICA CANADA, CHILE, VENEZUELA, USA,

ASIA CHINA, INDIA, INDONESIA, JAPAN, MALAYSIA, MALDIVES, THE PHILIPPINES, SINGAPORE, TAIWAN, VIETNAM

EUROPE BELGIUM, CROATIA, DENMARK, FINLAND, FRANCE, GERMANY, GREECE, ITALY, LITHUANIA

NETHERLAND, NORWAY, PORTUGAL, ROMANIA, SPAIN, SWEDEN, TURKEY, U.K

MIDDLE EAST & AFRICA EGYPT, ISRAEL, KUWAIT, U.A.E, QATAR, YEMEN, SOUTH AFRICA

SOUTH PACIFIC AUSTRALIA, NEW ZEALAND



The JMP Marine Engine Cooling Pumps and Spare Parts Support Program for CUMMINS / CATERPILLAR / DETROIT DIESEL

- Guaranteed highest quality components
- 100% comparability with Genuine Parts
- Even better value for money

ENGINE SERIES COVERAGE

CUMMINS	4BT, 6BT, 6CT, 855 SERIES, VTA903, K19, K38, QSB, QSC, QSM, QSK SERIES
CATERPILLAR	3208, 3304, 3306, 3406(E), 3408, 3412(E), C.4.4, C7, C9, C12, C18, C32
DETROIT DIESEL	3-53, 4-53, 6V-53, 3-71, 4-71, 6-71, 6V71, 8V-71, 12V-71, 16V-71, 6V-92, 8V-92T, 12V-92T, 16-92T, MTU S60, 2000 SERIES

THE ENGINE COOLING SPECIALISTS



Head Office

12 Mora-ro Sasang-gu Busan, Korea (46903)
Tel : +82-51-302-7337 Fax : +82-51-302-1255
Mail : jmp@jmp.co.kr
www.jmp.co.kr (Korean) / www.jmpusa.com (English)

JMP USA Office

13280 SW 131st, Suite 111 Miami, FL 33186 - USA
Tel : 305-677-8330 Fax : 305-677-8337
Mail : jmp@jmpusa.com